



LaCie d2 Thunderbolt 3 USB-C User Manual



Click here to access an up-to-date online version of this document. You will also find the most recent content as well as expandable illustrations, easier navigation, and search capability.

Contents

1	Regulatory Compliance	4
	FCC Declaration of Conformance	4
	FCC Class A Information	4
	FCC Caution	4
	Important Note: FCC Radiation Exposure Statement	4
	Industry Canada	5
	Important Note for mobile device use	5
	Note importante pour l'utilisation de dispositifs mobiles	5
	Europe – EU Declaration of Conformity	5
	Power source	7
2	Introduction	8
	Position and stacking	8
	Box content	8
	• Software suite	8
	Minimum computer system requirements	9
	• Thunderbolt 3	9
	• USB	9
	Views of the hard drive enclosure	9
	• Front view	9
	• Rear view	9
	Technical specifications	10
	• Power supply	10
	• Dimensions	10
	• Weight	10
3	LaCie d2 Thunderbolt 3 Advanced Storage	12
	LaCie d2 Thunderbolt 3	12
	Thunderbolt 3	12
4	System LEDs	14
	LED locations	14
	• Power off	14
	• Power on	14
	• Power-saving mode	14
	• Power-saving mode: daisy chain	15
	• Power-saving mode: managed by the PC/Mac	15
	LED behavior	15
	• Receiving power	16

5	Cables	17
	USB-C	17
	Cables	17
	• Thunderbolt 3 (USB-C) cable	17
	• USB 3.1 (USB-C)-to-USB Type A cable	18
6	Getting Connected	20
	Macs and Thunderbolt 3	20
	Windows and Thunderbolt 3	20
	Step 1 - Connect the interface cable	20
	Step 2 - Connect the power supply	21
	Step 3 - Launch LaCie Setup Assistant	22
	• Launch LaCie Setup Assistant - Windows	22
	• LaCie Setup Assistant - Mac	23
	• Setup	23
	Disconnecting the hard drive	24
7	Daisy Chain and Power Delivery	25
	Daisy chain Thunderbolt 3 devices	25
	How to daisy chain	25
	• Daisy chain: idle mode	26
	Power delivery	26
8	Unmounting Your Hard Drive	27
	Mac	27
	• Eject via Finder window	27
	• Eject via Desktop	27
	Windows 8 / Windows 10	27
9	Formatting and Partitioning	29
	About file system formats	29
	Formatting instructions	29
	• Mac	30
	• OS X version 10.11 or later	30
	• OS X version 10.6 to 10.10	30
	• Windows	30

Regulatory Compliance

FCC Declaration of Conformance

This device complies with Part 15 of the FCC Rules. Operation is subject to the following two conditions: (1) this device may not cause harmful interference, and (2) this device must accept any interference received, including interference that may cause undesired operation.

FCC Class A Information

This equipment has been tested and found to comply with the limits for a Class A digital device, pursuant to Part 15 of the FCC Rules. These limits are designed to provide reasonable protection against harmful interference in a residential installation. This equipment generates, uses and can radiate radio frequency energy and, if not installed and used in accordance with the instructions, may cause harmful interference to radio communications. However, there is no guarantee that interference will not occur in a particular installation.

If this equipment does cause harmful interference to radio or television reception, which can be determined by turning the equipment off and on, the user is encouraged to try to correct the interference by one of the following measures:

- Reorient or relocate the receiving antenna.
- Increase the separation between the equipment and receiver.
- Connect the equipment into an outlet on a circuit different from that to which the receiver is connected.
- Consult the dealer or an experienced radio/TV technician for help.

This device complies with Part 15 of the FCC Rules. Operation is subject to the following two conditions: (1) This device may not cause harmful interference, and (2) this device must accept any interference received, including interference that may cause undesired operation.

FCC Caution

Any changes or modifications not expressly approved by the party responsible for compliance could void the user's authority to operate this equipment.

Important Note: FCC Radiation Exposure Statement

This equipment complies with FCC radiation exposure limits set forth for an uncontrolled environment. This equipment should be installed and operated with minimum distance 20cm between the radiator and your

body. This transmitter must not be co-located or operating in conjunction with any other antenna or transmitter. The availability of some specific channels and/or operational frequency bands are country dependent and are firmware programmed at the factory to match the intended destination. The firmware setting is not accessible by the end user.

Industry Canada

This device complies with RSS-210 of the Industry Canada Rules. Operation is subject to the following two conditions: (1) This device may not cause harmful interference, and (2) this device must accept any interference received, including interference that may cause undesired operation.

Ce dispositif est conforme à la norme CNR-210 d'Industrie Canada applicable aux appareils radio exempts de licence. Son fonctionnement est sujet aux deux conditions suivantes: (1) le dispositif ne doit pas produire de brouillage préjudiciable, et (2) ce dispositif doit accepter tout brouillage reçu, y compris un brouillage susceptible de provoquer un fonctionnement indésirable.

Important Note for mobile device use

Radiation Exposure Statement: This equipment complies with IC radiation exposure limits set forth for an uncontrolled environment. This equipment should be installed and operated with minimum distance 20cm between the radiator & your body.

Note Importante pour l'utilisation de dispositifs mobiles

Déclaration d'exposition aux radiations:

Cet équipement est conforme aux limites d'exposition aux rayonnements IC établies pour un environnement non contrôlé. Cet équipement doit être installé et utilisé avec un minimum de 20 cm de distance entre la source de rayonnement et votre corps.

Europe – EU Declaration of Conformity

This device complies with the essential requirements of the EMC Directive 2004/108/EC. The following test methods have been applied in order to prove presumption of conformity with the essential requirements of the EMC Directive 2004/108/EC:

- EN 60950-1:2006/AC:2011: Information technology equipment - Safety - Part 1: General requirements
- EN 55022: 2010/AC:2011: Information technology equipment - Radio disturbance characteristics
 - Limits and methods of measurement
- EN 55024: 2010: Information technology equipment - Immunity characteristics - Limits and methods of measurement

Česky [Czech]	LaCie tímto prohlašuje, že tento direct attached storage device je ve shodě se základními požadavky a dalšími příslušnými ustanoveními směrnice 2004/5/ES.
Dansk [Danish]	Undertegnede LaCie erklærer herved, at følgende udstyr direct attached storage device overholder de væsentlige krav og øvrige relevante krav i direktiv 2004/5/EF.
Deutsch [German]	Hiermit erklärt LaCie, dass sich das Gerät direct attached storage device in Übereinstimmung mit den grundlegenden Anforderungen und den übrigen einschlägigen Bestimmungen der Richtlinie 2004/5/EG befindet.
Eesti [Estonian]	Käesolevaga kinnitab LaCie seadme direct attached storage device vastavust direktiivi 2004/5/EÜ põhinõuetele ja nimetatud direktiivist tulenevatele teistele asjakohastele sätetele.
English	Hereby, LaCie, declares that this direct attached storage device is in compliance with the essential requirements and other relevant provisions of Directive 2004/5/EC.
Español [Spanish]	Por medio de la presente LaCie declara que el direct attached storage device cumple con los requisitos esenciales y cualesquiera otras disposiciones aplicables o exigibles de la Directiva 2004/5/CE.
Ελληνική [Greek]	ΜΕ ΤΗΝ ΠΑΡΟΥΣΑ LaCie ΔΗΛΩΝΕΙ direct attached storage device ΣΥΜΜΟΡΦΩΝΕΤΑΙ ΠΡΟΣ ΤΙΣ ΟΥΣΙΩΔΕΙΣ ΑΠΑΙΤΗΣΕΙΣ ΚΑΙ ΤΙΣ ΛΟΙΠΕΣ ΣΧΕΤΙΚΕΣ ΔΙΑΤΑΞΕΙΣ ΤΗΣ ΟΔΗΓΙΑΣ 2004/5/ΕΚ.
Français [French]	Par la présente LaCie déclare que l'appareil direct attached storage device est conforme aux exigences essentielles et aux autres dispositions pertinentes de la directive 2004/5/CE.
Italiano [Italian]	Con la presente LaCie dichiara che questo direct attached storage device è conforme ai requisiti essenziali ed alle altre disposizioni pertinenti stabilite dalla direttiva 2004/5/CE.
Latviski [Latvian]	Ar šo LaCie deklarē, ka direct attached storage device atbilst Direktīvas 2004/104/EK būtiskajām prasībām un citiem ar to saistītajiem noteikumiem.
Lietuvių [Lithuanian]	Šiuo LaCie deklaruoja, kad šis direct attached storage device atitinka esminius reikalavimus ir kitas 2004/104/EB Direktyvos nuostatas.
Nederlands [Dutch]	Hierbij verklaart LaCie dat het toestel direct attached storage device in overeenstemming is met de essentiële eisen en de andere relevante bepalingen van richtlijn 2004/104/EG.
Malti [Maltese]	Hawnhekk, LaCie, jiddikjara li dan direct attached storage device jikkonforma mal-ħtiġijiet essenzjali u ma provvedimenti oħrajn rilevanti li hemm fid-Dirrettiva 2004/104/EC.
Magyar [Hungarian]	Alulírott, LaCie nyilatkozom, hogy a direct attached storage device megfelel a vonatkozó alapvető követelményeknek és az 2004/104/EC irányelv egyéb előírásainak.
Polski [Polish]	Niniejszym LaCie oświadcza, że direct attached storage device jest zgodny z zasadniczymi wymogami oraz pozostałymi stosownymi postanowieniami Dyrektywy 2004/104/EC.
Português [Portuguese]	LaCie declara que este direct attached storage device está conforme com os requisitos essenciais e outras disposições da Directiva 2004/104/CE.

Slovensko [Slovenian]	LaCie izjavlja, da je at direct attached storage device v skladu z bistvenimi zahtevami in ostalimi relevantnimi določili direktive 2004/104/ES.
Slovensky [Slovak]	LaCie týmto vyhlasuje, že direct attached storage device spĺňa základné požiadavky a všetky príslušné ustanovenia Smernice 2004/104/ES.
Suomi [Finnish]	LaCie vakuuttaa täten että direct attached storage device tyyppinen laite on direktiivin 2004/104/EY oleellisten vaatimusten ja sitä koskevien direktiivin muiden ehtojen mukainen.
Svenska [Swedish]	Härmed intygar LaCie att denna direct attached storage device står i överensstämmelse med de väsentliga egenskapskrav och övriga relevanta bestämmelser som framgår av direktiv 2004/104/EG.

Power source



Caution: Use the product with the provided power cable only.



Note: To protect your data, always follow the safe removal procedures for your operating system when disconnecting your product.

Introduction

Welcome to the LaCie d2 Thunderbolt™ 3 User Manual. Thunderbolt 3 supports transfer rates up to 40Gb/s, making the LaCie d2 ideal for professional editors, photographers and graphic artists who work with bandwidth-intensive content such as 4K video and 3D graphics.

You can get the latest tips regarding your product and updated technical information at [LaCie customer support](#).

Position and stacking

Always make certain to place the LaCie d2 on a flat, even surface that can support the heat output and airflow of a professional hard drive enclosure. For proper heat dissipation, the LaCie d2 is designed to stand upright. DO NOT place the enclosure on its side when it is powered on.

The LaCie d2 does not support stacking. Doing so poses a severe risk that it will fall. DO NOT stack other drives, enclosures, or equipment on top of the LaCie d2.

The warranty for your LaCie d2 will be voided if you:

- Stack the LaCie d2 enclosure on another device.
- Stack other drives, enclosures, or equipment on top of the LaCie d2.

Box content

- LaCie d2
- Thunderbolt 3 (USB-C) cable
- USB 3.1 (USB-C) to USB 3.0/USB 2.0 adapter cable (compatible with Type A ports)
- External power supply
- Quick Install Guide



Important info: Save your packaging. In the event that the hard drive enclosure should need to be repaired or serviced, it must be returned in its original packaging.

Software suite

During installation, you have the option to install the following software utilities:

- Intego® Backup Assistant (Mac®)

- LaCie Genie® Timeline (Windows®)

Minimum computer system requirements

The minimum operating system for your computer differs based upon the port you are using. Choose your port and connect your LaCie device to a computer that meets the following minimum system requirements.

Thunderbolt 3

- Mac OS Sierra or higher
- Windows 10 or higher

USB

- Mac OS X 10.10 or higher
- Windows 8.1 or higher

Views of the hard drive enclosure

Front view

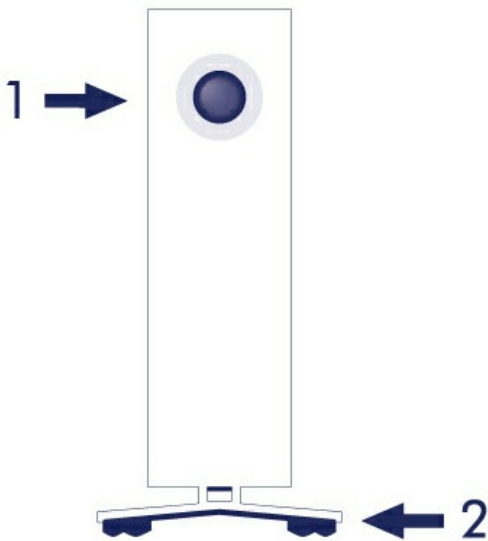

1. Hard drive status LED
2. Vibration-dampening rubber feet

Rear view

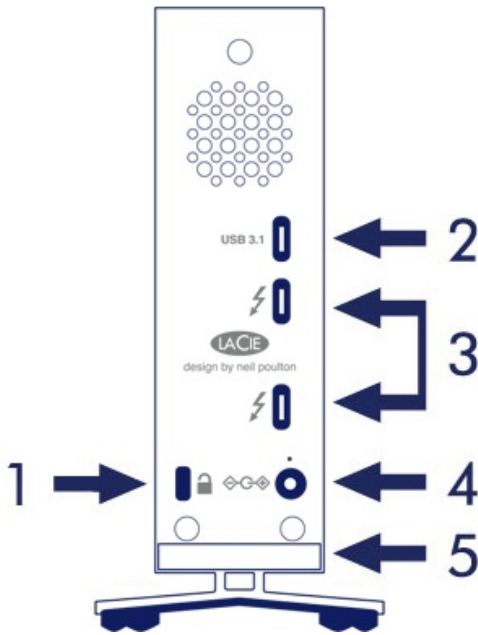

1. Kensington® lock slot
2. USB 3.1 port
3. Thunderbolt 3 ports (x2)
4. Power supply connection
5. Integrated cable lock

Technical specifications

Power supply

100-240V; 50/60Hz; 60W

Dimensions

Width	Depth	Height
60 mm / 2.4 in	217 mm / 8.5 in	130 mm / 5.1 in

Weight

Capacity	Weight
6TB	1.4 Kg / 3.0 lbs
8TB	1.4 Kg / 3.0 lbs
10TB	1.3 Kg / 2.9 lbs

LaCie d2 Thunderbolt 3 Advanced Storage

LaCie d2 Thunderbolt 3

The LaCie d2 Thunderbolt 3 features:

- Desktop convenience
- Aluminum front and all-metal enclosure
- Two Thunderbolt 3 technology ports, up to 40Gb/s bi-directional per port
- USB 3.1 port, up to 5Gb/s
- Daisy chain Thunderbolt 3 devices (up to 6 Thunderbolt products, plus one USB-C or DisplayPort device)



Note: Any non-Thunderbolt 3 devices must be connected to the end of the daisy chain.

Thunderbolt 3

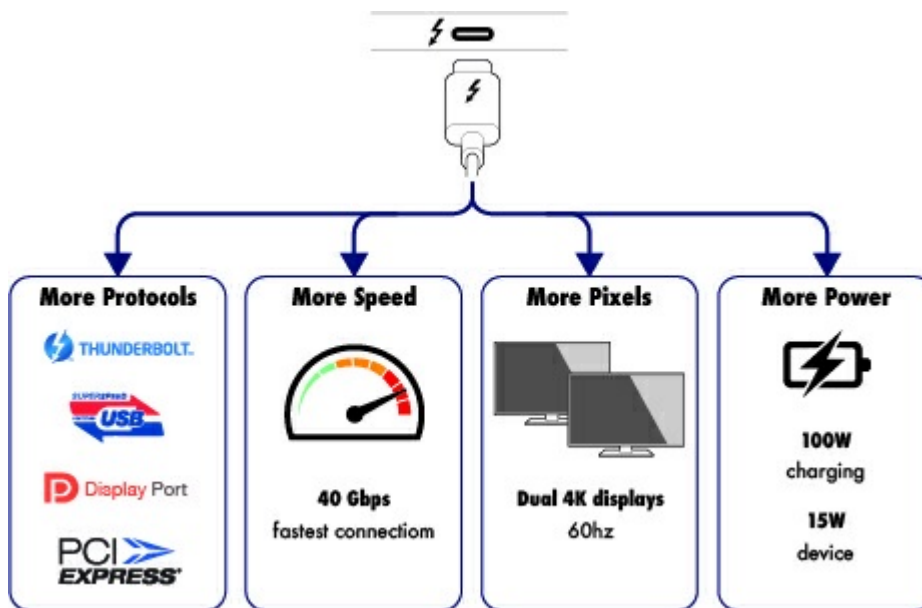

Thunderbolt 3 features and support

Thunderbolt 3 technology provides the fastest data and high-end video transfers over a single, versatile connector. While previous generations of Thunderbolt technology offered impressive transfer rates up to 20Gb/s bi-directional, Thunderbolt 3 doubles the potential up to 40Gb/s bi-directional when connected to other Thunderbolt 3 devices. Further, Thunderbolt 3 gives priority to the video stream, apportioning the required bandwidth for playback. This is a critical advantage when working with high-end video and 3D graphics.

Thunderbolt 3 uses a USB-C connector specially labeled with a thunderbolt icon. Since Thunderbolt 3 is protocol agnostic, it supports connections from the following interfaces:

- USB 2.0, USB 3.0 and USB 3.1
- DisplayPort 1.1 and 1.2a
- Thunderbolt 20Gb/s and Thunderbolt 40Gb/s
- Ethernet (with adapter)

Non-Thunderbolt 3 devices that feature USB-C ports can be connected to the Thunderbolt 3 port to terminate a daisy chain and, if compatible, to take advantage of the power delivery option for charging batteries.

System LEDs

Your LaCie hard drive features a multi-functional LED on the front of the drive.

LED locations

The LED is a button that can be used to power on/off the LaCie d2.

Power off

Follow the steps below to turn the device off:

1. Make certain that the LaCie d2's volumes are not being accessed.
2. Eject the LaCie d2's volumes. See [Unmounting Your Hard Drive](#) for instructions. Once the volumes have been properly ejected, the LaCie d2 enters power-saving mode.
3. Apply a long press, a minimum of four seconds, to the LED button. The LED turns solid blue before turning off.

Power on

In most instances, the LaCie d2 powers on automatically when connected to a computer and an active power source. However, the LED button can be used to power on the device if the following two conditions are met:

- The LaCie d2 was powered off using a long press
- The LaCie d2 remains connected to the computer's USB port and an active power source

To power on the LaCie d2, push the LED button for one second.

Power-saving mode

Your LaCie d2 can conserve energy by entering power-saving mode. The hard drive within the enclosure spins down to reduce power consumption when the LaCie d2 is in power-saving mode. Power-saving mode can extend the life of the hard drive by sparing it from working during extended periods of inactivity. The LaCie d2 can be placed into power-saving mode using the LED button when it is connected via the Thunderbolt 2 port. To place the LaCie d2 into power-saving mode:

1. Make certain that the LaCie d2's volumes are not being accessed.
2. Eject the volumes (see [Unmounting Your Hard Drive](#)).
3. Apply a short press to the LED button. A short press lasts no longer than 1 second.

To wake up the LaCie d2, apply another short press.

Power-saving mode: daisy chain

You can daisy chain Thunderbolt 3 technology devices when the LaCie d2 is in power-saving mode. Though the hard drive spins down when the LaCie d2 enters power-saving mode, the Thunderbolt signal remains constant. Therefore, daisy-chained devices continue data operations without interruption. See [Daisy Chain and Power Delivery](#) for further details.

Power-saving mode: managed by the PC/Mac

You can initiate power-saving mode on your computer by performing one of the following:

- Place the host computer into sleep mode.
- Mac: Go to **System Preferences > Energy Saver** to enable sleep mode for hard drives.
- Windows 8: Go to **Control Panel > Hardware > Power Options > Choose a power plan > Change advanced power settings**. Click on Hard disk and Turn off the hard disk after. Choose the time to spin down USB hard drives.

To exit power-saving mode, review the table below:

Entering power-saving mode	Exiting power-saving mode
The host computer placed the product into power-saving mode due to inactivity.	Access the LaCie d2's volume on the host computer. For example, copy files to its volume.
The computer is in sleep mode.	Wake up the computer.



Note on ejecting the volume and power-saving mode: The LaCie d2 enters power-saving mode when its volumes are ejected. To access the LaCie d2's volumes, unplug the USB cable from the back of the device and reconnect it.

LED behavior

The list of colors below helps you identify the general status of your LaCie d2.

Color	State
Off	The product is turned off; the USB-C cable is not connected to a computer that is turned on and/or the power cable is not connected to a live power outlet.
Solid blue	Ready

Blinking blue	During normal operation, the LED flickers to indicate access to the hard drive.
Slow blinking blue (10 sec. interval)	The product is in power-saving mode because the host computer is in sleep mode. See Technical note below.
Fast blinking blue	Startup and shutdown
Blinking red (1 sec. interval)	Temperature warning or fan failure.
Solid red	Temperature critical or fan absent.

! **Warning:** Some devices may experience false indications of fan failure. When this occurs, the red LED appears even though there are no problems with the fan. If your device's LED turns red on one or many occasions, please see this [article](#) for more details.



Technical note regarding power-saving mode and Windows: The LaCie d2 can be placed into power-saving mode on PC's running Windows 8 or higher. However, it is possible that the LED will remain off rather than flash blue every 10 seconds.

Receiving power

The LaCie d2 powers on automatically when it is:

- Connected directly to a computer via the Thunderbolt 3 or USB-C ports. The computer must be powered on.
- Connected to a live power source via the included power supply.



Important info regarding the ports: The LaCie d2 can be connected to a computer using the USB 3.1 port or the Thunderbolt 3 port. However, it is not possible to connect both ports to a single computer at the same time or, to connect each port to separate computers.

Cables

USB-C

USB 2.0 480 Mb/s	USB 3.1 5 Gb/s	USB 3.1 10 Gb/s	DisplayPort Multi-Function 5 or 10 Gb/s	Thunderbolt 3 20 or 40 Gb/s
				

USB-C protocols

USB is a serial input/output technology for connecting peripheral devices to a computer. USB-C is the latest implementation of this standard and it provides convenient connector, higher bandwidth and all-new power management features. Further, USB-C ports that feature the Thunderbolt icon support Thunderbolt 3 devices.

USB-C supports many protocols:

- Thunderbolt 3: transfer rates up to 40Gb/s
- USB 3.1 Gen 2: transfer rates up to 10Gb/s
- USB 3.1 Gen 1: transfer rates up to 5Gb/s
- SuperSpeed USB 3.0: transfer rates up to 5Gb/s
- Hi-Speed USB 2.0: transfer rates up to 480Mb/s
- DisplayPort: up to 8K with compatible devices and backwards compatible to VGA and DVI

Cables

Your LaCie hard drive is shipped with two cables for universal compatibility with all modern computers:

- Thunderbolt 3 (USB-C)
- USB 3.1 (USB-C) to USB 3.0/USB 2.0 adapter cable (compatible with Type A ports)

! Make certain to use the USB-C cable included with your device. Due to poor construction, many third-party USB-C cables can cause irreparable harm to devices such as your computer and LaCie device. LaCie is not responsible for damage to your LaCie d2 Thunderbolt 3 caused by third-party cables.



Thunderbolt 3 (USB-C) cable

Thunderbolt 3 can attain up to 40Gb/s as opposed to Thunderbolt 2's 20Gb/s.



Use the included Thunderbolt 3 (USB-C) cable to ensure maximum data transfer performance when used with compatible ports.





Connecting your product is easy since the USB-C cable is identical on both ends. Further, the USB-C ports on your LaCie hard drive and computer are conveniently rounded to accept the cable end no matter how it is connected. This cable can be connected to either the port marked USB 3.1 or either of the Thunderbolt 3 ports on the back of the device.

Connector face	Cable end
	

USB 3.1 (USB-C)-to-USB Type A cable

Use the USB 3.1 (USB-C)-to-USB Type A cable for compatibility with computers that do not have a USB-C port. The USB-C end is connected to the LaCie hard drive and the Type A end is connected to the computer's USB 3.0 or USB 2.0 Type A port.

Hard drive performance is limited to USB 3.0 transfer rates when connected to a USB 3.0 port and, USB 2.0 transfer rates when connected to a USB 2.0 port.

Connector face (USB Type A to computer)	Cable end (USB Type A to computer)	Connector face (USB-C to product)	Cable end (USB-C to product)
			

Getting Connected

Follow the setup steps in the order they are given to ensure that your LaCie hard drive's volume mounts correctly on your computer.

Macs and Thunderbolt 3

The Thunderbolt 3 connection can be used on a Mac with a Thunderbolt 3 port to reach transfer rates up to 40Gb/s bi-directional.

Using the Thunderbolt 3 connection with first or second generation Thunderbolt ports requires an adapter (sold separately) and will result in lower transfer rates (20Gb/s bi-directional for Thunderbolt 2 ports, and 10Gb/s bi-directional for first generation Thunderbolt ports).

Windows and Thunderbolt 3

Your LaCie Thunderbolt 3 storage device is certified for use with Windows PCs that have a Thunderbolt 3 port. However, you may experience connectivity issues between the storage device and the Thunderbolt 3 port on a Windows PC. Therefore, before setting up your LaCie Thunderbolt 3 storage device, please visit your PC manufacturer's website to update your Windows PC to the latest versions of:

- BIOS
- Thunderbolt 3 firmware
- Thunderbolt 3 driver

Make certain that your PC has the most recent version of Windows 10. For questions regarding your PC, please contact the PC manufacturer. You can also review the following website for additional information: <https://thunderbolttechnology.net/updates>.

This issue pertains to the Thunderbolt 3 port and does not affect USB ports.

Step 1 - Connect the interface cable

Connect the interface cable from the LaCie d2 to the computer.

- USB 3.1 (USB-C) to USB-C

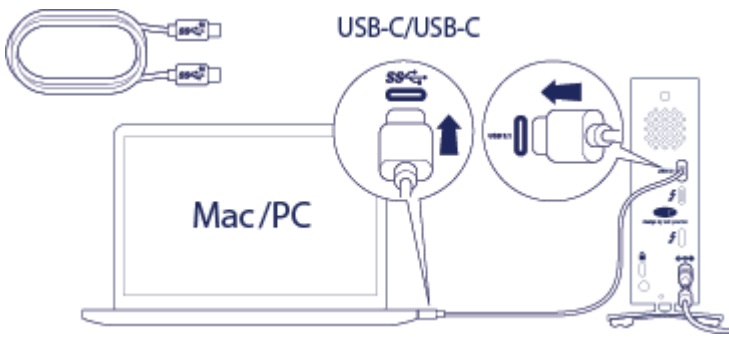

- Thunderbolt 3 to Thunderbolt

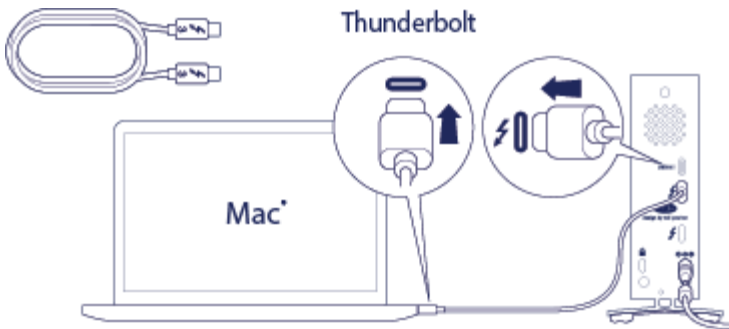

- USB 3.1 (USB-C) to USB-A (USB 3.0 & 2.0)

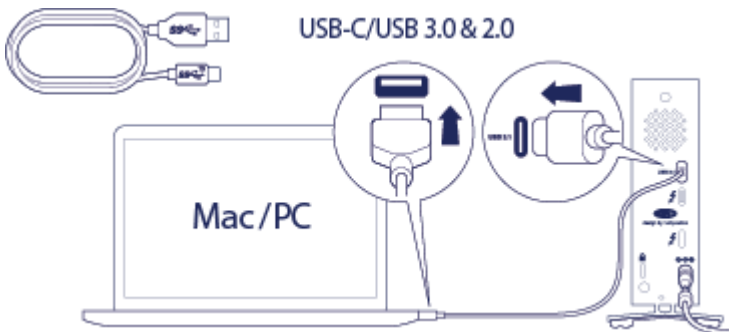

Step 2 - Connect the power supply

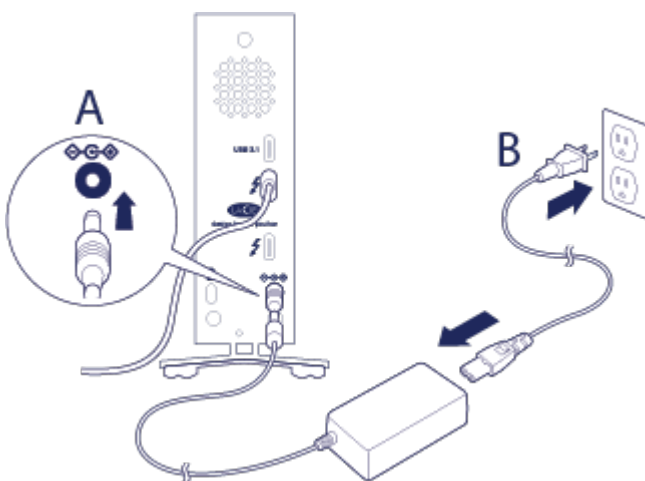

Connect the power supply in the following order:

1. The power input port on the back of the LaCie d2.
2. A live power outlet.

The LaCie d2 will power on automatically when it is connected to a computer that is turned on and a live power outlet.

Step 3 - Launch LaCie Setup Assistant

LaCie Setup Assistant (LSA) must be launched before using your drive. It will allow you to:

- Easily format the hard drive according to your needs
- Copy the User Manual to your computer
- Install software for added features
- Register your LaCie device

! **Important info:** If you do not launch LSA or if you quit it after the formatting has begun, your drive will not be ready to use and will require manual formatting. The User Manual and utilities will not be available and will have to be downloaded from the LaCie website: www.lacie.com/support/.

Launch LaCie Setup Assistant - Windows

AutoPlay: Windows AutoPlay may detect your LaCie hard drive as soon as it is connected to your computer. If the AutoPlay window appears, choose **Open folder to view files** and double-click **LaCie Setup**.

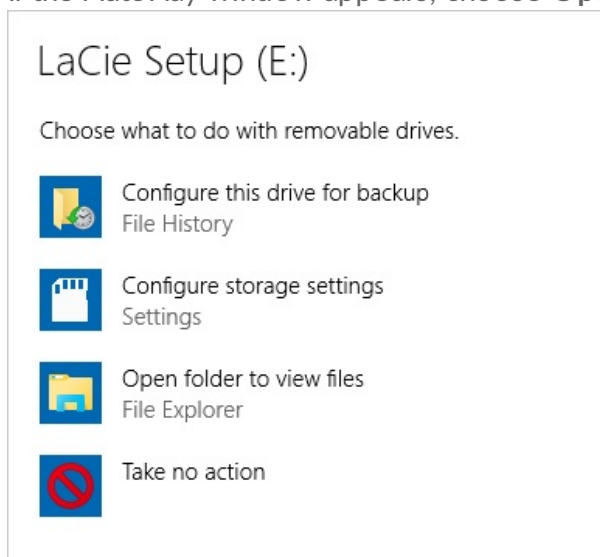

Manual access: Open the **LACIE SETUP** volume in **Computer (My Computer for Windows XP)** and double-click **LaCie Setup**.

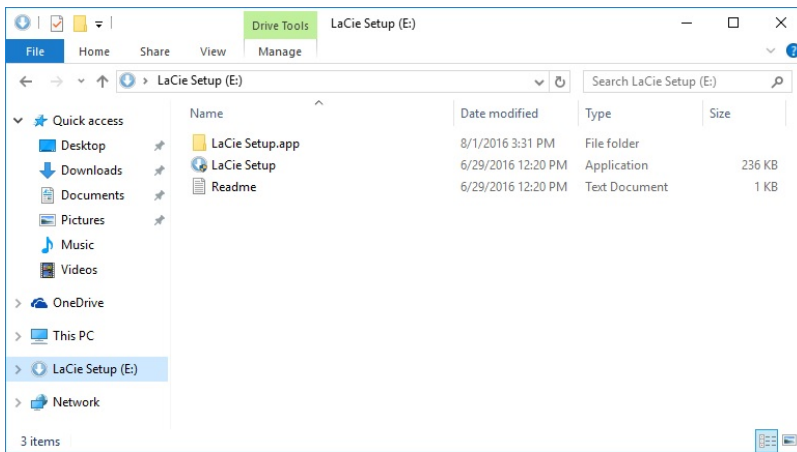

LaCie Setup Assistant - Mac

Open the **LACIE SETUP** volume on your desktop and then double-click **LaCie Setup**

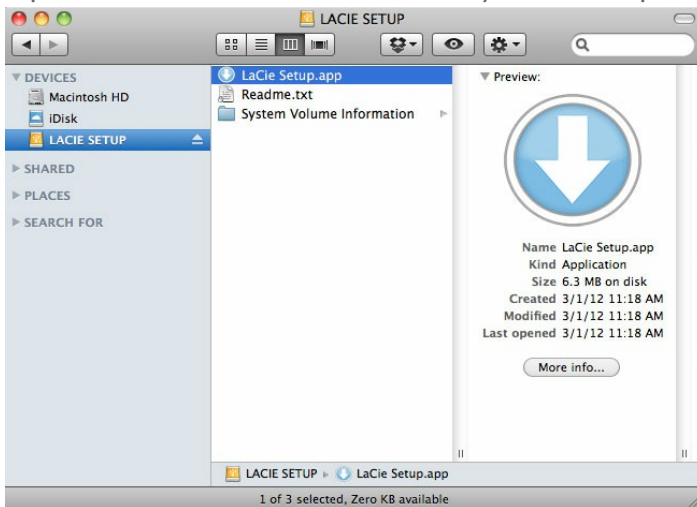

Setup

LaCie Setup Assistant does not prevent you from using your computer's native disk utility program to format or partition your LaCie drive. Simply follow the Setup Assistant through completion, then use Disk Management for Windows or Disk Utility for Mac to reformat your drive.

! **Important info for Windows users:** While running LaCie Setup Assistant, generic pop-up windows may ask if you wish to change your computer's settings. This is a normal request when formatting a disk or installing certain software, such as Genie Timeline. To successfully complete LaCie Setup Assistant, LaCie recommends that you agree to change the settings.

! **Important info for Mac users:** You may be prompted to enter your computer password to continue with LaCie Setup Assistant.

! **Important info regarding Mac OS X:** Certain versions of LaCie Setup Assistant are not compatible with USB connections on Macintosh computers running Mac OS X 10.11, also known as El Capitan. If LaCie Setup Assistant experiences problems, you can try connecting your LaCie storage using another interface port on your computer (e.g. FireWire 800 or Thunderbolt). If you are unable to use another interface port, format your LaCie hard drive using Disk Utility. For instructions on how to format your LaCie hard drive for Mac, see the chapter **Formatting and Partitioning > Mac Users**.

1. Select your language.
2. Read the license agreement before choosing **Next**. Selecting **Next** confirms that you accept the license agreement.
3. Use the slider to partition your LaCie hard drive. There are two options for partitions:
 - **LaCie Share:** formatted as FAT32 for compatibility with Windows and Mac.
 - **LaCie:** formatted for your operating system, NTFS for Windows or HFS+ for Mac.Move the slider to the left to reduce the size of the **LaCie Share** partition. If you do not want the **LaCie Share** volume, move the slider all the way to the left.
4. A prompt alerts you that the disk will be formatted. Select **Yes** to continue. LaCie Setup Assistant formats the hard drive.
5. Register your LaCie device.
6. Choose the software utilities that you want to install. Certain software utilities may begin to install before LaCie Setup Assistant has finished. Follow the software utility installer before completing LaCie Setup Assistant. If you do not install software utilities during this step, you can return to LaCie Setup Assistant at any time.
7. LaCie Setup Assistant provides a summary of the installation. Choose **Finish** to close the program.

To install software utilities after the initial installation, you can run LaCie Setup Assistant again. Since the format is complete you are only prompted to choose software utilities. LaCie Setup Assistant is available on:

- **LaCie Share:** if you created two partitions
- **LaCie:** if you created one partition

Disconnecting the hard drive

In order to avoid file system corruption, it is important to unmount your hard drive's volumes before disconnecting the interface cable. See [Unmounting Your Hard Drive](#) for details.

Daisy Chain and Power Delivery

Use the two Thunderbolt 3 ports on the LaCie d2 Thunderbolt 3 for:

- Direct connection to a computer that is compatible with Thunderbolt 3 technology.
- Daisy chaining with devices and displays that are compatible with Thunderbolt 3 technology.
- Charging the batteries of compatible devices.

Daisy chain Thunderbolt 3 devices

Thunderbolt 3 is an update of Thunderbolt 2 technology. While Thunderbolt 2 technology continues to provide impressive transfer rates up to 20Gb/s bi-directional, Thunderbolt 3 offers improved performance with a potential up to 40Gb/s bi-directional. Thunderbolt 3 technology also gives you greater flexibility when using video and data, assigning greater throughput to the stream that carries the heavier load. You must have a computer that supports Thunderbolt 3 to take advantage of the updates in performance and the intelligent sharing of bandwidth.

Similar to Thunderbolt 2 technology, a single Thunderbolt 3 daisy chain can have up to seven devices, including the computer. For example, you can daisy chain five LaCie d2 Thunderbolt 3 enclosures on the same line with a display.

How to daisy chain

Connect the cable to one of the interface ports on the back of LaCie d2 and to your computer. The additional port on LaCie d2 can be used to daisy chain compatible Thunderbolt 3 peripherals, such as hard drives and monitors. If you have another Thunderbolt 3 storage device, make certain to connect it to the daisy chain before adding compatible displays or USB 3.1 (USB-C) devices. See below for an example of the order of devices in a Thunderbolt 3 daisy chain.

1. Computer with a Thunderbolt 3 port
2. LaCie d2 Thunderbolt 3
3. LaCie 12big Thunderbolt 3 (Thunderbolt 3 ports)
4. LaCie 6big Thunderbolt 3 (Thunderbolt 3 ports)
5. LaCie Bolt 3 (Thunderbolt 3 ports)

USB 3.1 (USB-C) devices can terminate a Thunderbolt 3 daisy chain and should always be the last device.



Important cable info: When connecting your enclosure to a computer or compatible devices, use cables specifically constructed to support Thunderbolt 3.



Important info: To reach Thunderbolt 3 transfer rates up to 40Gb/s bi-directional, LaCie d2 Thunderbolt 3 must be connected to a computer that supports Thunderbolt 3 technology.

Daisy chain: idle mode

You can daisy chain Thunderbolt 3 devices even when the LaCie d2 hard drives are spun down. Apply a short push on the LED power button. The status LED blinks slowly, indicating that the LaCie d2 is in idle mode.

Power delivery

Each Thunderbolt 3 port on LaCie d2 outputs up to 15W of power, and the USB 3.1 port delivers up to 27W. You can connect compatible devices that support charging via USB-C to the ports. LaCie d2 must receive power via its power cable to deliver power to compatible devices.



LaCie is not responsible for devices that experience harm, damage or malfunction when connected to LaCie d2.

Unmounting Your Hard Drive

USB, FireWire, Thunderbolt, and eSATA external devices feature “plug & play” connectivity, which means that your LaCie storage can be connected and disconnected while the computer is running. However, always eject a storage drive from your computer before physically disconnecting it. Your computer must perform filing and housekeeping operations on the drive before it's removed. Therefore, if you unplug the drive without using the operating system's software, your files can become corrupt or damaged.

Mac

There are several ways you can eject your hard drive from a Mac. See below for two options.

Eject via Finder window

1. Open a Finder window.^[?]
2. On the sidebar, go to Devices to locate LaCie and click the eject symbol to the right of the drive name.
3. Once the hard drive disappears from the sidebar or, the Finder window closes, you can disconnect the hard drive's cable from your Mac.

Eject via Desktop

1. Select the desktop icon for your hard drive and drag it to the Trash. (The icon pictured below is a generic USB device icon. Your LaCie storage may be represented by an icon that looks like the device itself.)

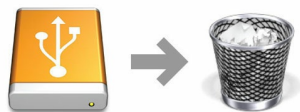

2. When the hard drive's icon is no longer visible on your desktop, you can physically disconnect the hard drive from your Mac.

Windows 8 / Windows 10



Thunderbolt 3 is only compatible with Windows 10, however, the USB-C-to-USB Type A adapter cable can be used with Windows 7 and 8.

Use the Safely Remove tool to eject a hard drive.

1. Click the Safely Remove icon in your Windows System Tray to view the devices you can eject.

2. If you don't see the Safely Remove Hardware icon, click the Show hidden icons arrow in the system tray to display all icons in the notification area.²

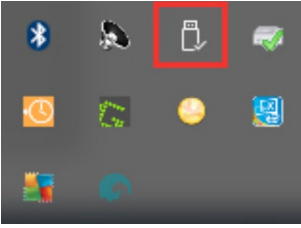

3. In the list of devices, choose the device you want to remove. Windows displays a notification when it is safe to remove the device.²
4. Disconnect the hard drive from the computer.

Formatting and Partitioning

Standard LaCie storage devices will prompt you to run LaCie Setup Assistant when they are first connected to a PC or Mac. LaCie Setup Assistant helps you to quickly format the storage device according to your needs. Please read the information below carefully if you:

- Abort LaCie Setup Assistant while it is formatting.
- Wish to reformat your storage device after LaCie Setup Assistant has successfully completed.
- Own a LaCie storage device that does not feature Setup Assistant.

About file system formats

NTFS: since it is the native file system for Windows, volumes created in NTFS are read and write with computers running Windows. Mac OS can read NTFS volumes but cannot natively write to them.

Mac OS Extended (HFS+): the native hard drive file system for Mac. Windows cannot natively read or write to HFS+ (journaled) hard drives.

exFAT: generally compatible with Mac and Windows. exFAT is not a journaled file system which means it can be more susceptible to data corruption when errors occur or the drive is not disconnected properly from the computer.

FAT32: compatible with Mac and Windows. However, FAT32 is a legacy file system designed for low capacity hard drives and it is not recommended for modern hard drives or operating systems. A FAT32 partition can reach up to 32GB when formatted on a Windows PC.

How to choose the file system format

Use NTFS if:

...the storage device is connected to Windows PCs.

Use HFS+ if:

...the storage device is connected to Macs.

You can use exFAT if:

...the storage device is shared between Mac and Windows computers.

Use FAT32 if:

...the storage device is connected to older Windows and Mac computers. FAT32 is not recommended for modern operating systems and computers.

Formatting instructions

The steps below help you format and partition a storage device.

! **Caution:** Formatting erases everything on the storage device. LaCie highly recommends that you back up all data on your storage device before performing the steps below. LaCie is not responsible for any data lost due to formatting, partitioning or using a LaCie storage device.



Note: Refer to your operating system's documentation for more information on formatting and partitioning storage devices.

Mac

OS X version 10.11 or later

1. Open the Finder and go to **Applications > Utilities > Disk Utility**.
2. In the sidebar to the left, select your LaCie d2 drive.
3. Select **Erase**.
4. A dialog box opens. Enter a name for the drive. This will be the name displayed when the drive mounts.
5. For Format, select **OS X Extended (Journaled)**.
6. For Scheme, select **GUID Partition Map**.
7. Click **Erase**.
8. Disk Utility will format the drive. When it's finished, click **Done**.

OS X version 10.6 to 10.10

1. Open the Finder and go to **Applications > Utilities > Disk Utility**.
2. In the sidebar to the left, select the LaCie d2 drive that shows the capacity.
3. In the Disk Utility window, select the **Partition** tab.
4. Under Partition Layout, select **1 partition**.
5. Enter a name for the drive. This will be the name displayed when the drive mounts.
6. For Format, select **OS X Extended (Journaled)**.
7. Click on Options. Select **GUID Partition Map**, and then click **OK**.
8. Click **Apply**.
9. A dialog appears advising you that this is a data destructive process and any data currently on the drive will be deleted.
10. Select **Partition** to complete the formatting process.

Windows

1. Make sure the storage device is connected to and mounted on the computer.
2. Go to Search and then type **diskmgmt.msc**. In the search results, double click **Disk Management**.
3. From the list of storage devices in the middle of the Disk Management window, locate your LaCie device.
4. The partition must be available to format. If it is currently formatted, right click on the partition and then choose **Delete**.
5. To create a new partition, right click on the volume and select **New Simple Volume**. Follow the on-screen instructions when the New Simple Volume Wizard appears.

