

# Table of Contents

<b>1. Introduction.....</b>	<b>7</b>
1.1. Minimum System Requirements.....	8
1.1.1. Windows Users.....	8
1.1.2. Mac Users.....	8
1.2. Supported Formats.....	9
1.3. Box Content.....	10
1.4. Languages.....	10
1.5. Views of the LaCinema HD Connect.....	11
1.5.1. Front View.....	11
1.5.2. Rear View.....	11
1.6. Cables and Connectors.....	12
1.6.1. A/V (Audio/Video) Cables.....	12
1.7. Power Management.....	13
<b>2. Using the Remote Control.....</b>	<b>14</b>
2.1. Battery Installation.....	14
2.2. Remote Control Key Index.....	15
2.2.1. Important Button Details.....	16
<b>3. Setting Up: Connecting to TV &amp; Network.....</b>	<b>17</b>
3.1. STEP 1: Connect HDMI or Composite Cables.....	17
3.1.1. HDMI (High-Definition) Connection.....	18
3.1.2. Composite Video & Stereo Audio Connection.....	18
3.1.3. Optical Audio (S/PDIF) Connection.....	19
3.2. STEP 2: Connect to the Network.....	20
3.3. STEP 3: Connect the Power Supply.....	21
3.4. STEP 4: Complete the Installation Wizard.....	22
<b>4. Setting Up: Connecting USB Hard Drive.....</b>	<b>24</b>
4.1. About External USB Hard Drives.....	24
4.1.1. Compatibility.....	24
4.2. STEP 1: Connect Hard Drive to Computer.....	25
4.3. STEP 2: Load Files.....	25
4.4. STEP 3: Safely Disconnect Hard Drive from Computer.....	26
4.5. STEP 4: Connect Hard Drive to LaCinema HD Connect.....	27
4.6. Safely Disconnect Hard Drive from LaCinema HD Connect.....	27
<b>5. Playing Multimedia Files.....</b>	<b>28</b>
5.1. Movie Space.....	29
5.1.1. Movie Space Options.....	30
5.2. Photos Space.....	32
5.2.1. Photo Space Options.....	33
5.3. Music Space.....	34
5.3.1. Music Space Options.....	36
5.4. Network Space.....	38
5.4.1. Media Servers.....	38
5.4.2. Shared folders.....	38
<b>6. Playing Files From a Networked Media Server.....</b>	<b>39</b>
6.1. Network-Attached Storage (NAS).....	39
6.2. From Windows or Mac Computers.....	40

---

6.2.1. Packet Video TwonkyVision .....	40
6.2.2. Windows Media Player (WMP) .....	41
6.2.3. Shared folders on your Computer.....	42
<b>7. Sharing Files Throughout Your Home Network .....</b>	<b>45</b>
7.1. Manage Files from a Networked Computer .....	45
7.1.1. STEP 1: Verify Physical Connection .....	46
7.1.2. STEP 2: LaCie Network Assistant: Install.....	46
7.1.3. STEP 3: LaCie Network Assistant: Manage Files.....	47
7.1.4. Alternative Network Connection Methods.....	49
<b>8. Formatting External USB Hard Drives .....</b>	<b>50</b>
8.1. Formatting: Windows Users.....	51
8.2. Formatting: Mac Users.....	53
<b>9. Settings Menu .....</b>	<b>54</b>
9.1. Settings: Audio/Video .....	54
9.1.1. Video Output .....	54
9.1.2. Display Resolution.....	55
9.1.3. Aspect Ratio .....	55
9.1.4. Audio Output .....	55
9.1.5. NTSC/PAL.....	56
9.2. Settings: Video .....	56
9.2.1. Video Sequence.....	56
9.2.2. Subtitle Font Size.....	57
9.3. Settings: Music .....	58
9.3.1. Music Sequence .....	58
9.3.2. Audio Track Display .....	58
9.4. Settings: Photo .....	59
9.4.1. Slideshow.....	59
9.4.2. Picture Scaling.....	59
9.4.3. Transition Effect .....	60
9.4.4. Interval Time .....	60
9.5. Settings: System.....	61
9.5.1. Language.....	61
9.5.2. Content Aggregation.....	61
9.5.3. Screensaver Delay.....	61
9.5.4. Browse Mode .....	61
9.5.5. Additional Encoding Support.....	62
9.5.6. System Reset.....	62
9.5.7. About .....	63
9.5.8. Update Device.....	63
9.6. Settings: Network .....	64
9.6.1. Network Setup: Wired / Wireless .....	64
9.6.2. Device Name .....	65
9.6.3. Shared Folders .....	65
9.6.4. Auto Login .....	66
9.6.5. Clear Account Information.....	66
9.7. Settings: Shutdown .....	66
9.7.1. Shutdown.....	66
9.7.2. Restart .....	66
<b>10. Troubleshooting .....</b>	<b>67</b>
10.1. Troubleshooting the Television/Stereo Connection.....	68
10.2 USB Hard Drive Connection .....	69

<b>11. Contacting Customer Support .....</b>	<b>70</b>
11.1 LaCie Technical Support Contacts.....	71
<b>12. Warranty Information .....</b>	<b>72</b>

## Copyrights

Copyright © 2012 LaCie. All rights reserved. No part of this publication may be reproduced, stored in a retrieval system, or transmitted in any form or by any means, electronic, mechanical, photocopying, recording or otherwise, without the prior written consent of LaCie.

## Trademarks

Apple, Mac, and Macintosh are registered trademarks of Apple Inc. Microsoft, Windows XP, Windows Vista, and Windows 7 are registered trademarks of Microsoft Corporation. Other trademarks mentioned in this manual are the property of their respective owners.

Manufactured under license from Dolby Laboratories. "Dolby" and the double-D symbol are trademarks of Dolby Laboratories.



## Changes

The material in this document is for information only and subject to change without notice. While reasonable efforts have been made in the preparation of this document to assure its accuracy, LaCie assumes no liability resulting from errors or omissions in this document, or from the use of the information contained herein. LaCie reserves the right to make changes or revisions in the product design or the product manual without reservation and without obligation to notify any person of such revisions and changes.

## FCC Statement



This device complies with Part 15 of the FCC Rules. Operation is subject to the following conditions:

1. The devices may not cause harmful interference
2. The devices must accept any interference received, including interference that may cause undesired operation.

NOTE: This equipment has been tested and found to comply with the limits for a Class B digital device, pursuant to Part 15 of the FCC Rules. These limits are designed to provide reasonable protection against harmful interference in a residential installation. This equipment generates, uses and can radiate radio frequency energy and, if not installed and used in accordance with the instructions, may cause harmful interference to radio communications. However, there is no guarantee that interference will not occur in a particular installation. If this equipment does cause harmful interference to radio or television reception, which can be determined by turning the equipment off and on, the user is encouraged to try and correct the interference by one or more of the following measures:

- Reorient or relocate the receiving antenna.
- Increase the separation between the equipment and receiver.

- Connect the equipment into an outlet on a circuit different from that to which the receiver is connected.
- Consult the dealer or an experienced radio/TV technician for help.

Modifications to this product not authorized by LaCie could void the FCC & Industry Canada regulations and negate your authority to operate the product.

## Canada Compliance Statement

This Class B digital apparatus meets all requirements of the Canadian Interference-Causing Equipment Regulations.

## CE Manufacturer's Declaration for CE Certification

We, LaCie, solemnly declare that this product conforms to the following European directives: 2004/108/EC (EMC), and 2006/95/EC (Safety)

**CAUTION:** Modifications not authorized by the manufacturer may void the user's authority to operate this device.

**CAUTION:** The LaCinema HD Connect's warranty may be void as a result of the failure to respect the precautions listed above.

**NOTE:** The main cable must be in conformity with CEI 60227 or CEI 60245 and the type of plug must match the standards in the country of use.





This symbol on the product or on its packaging indicates that this product must not be disposed of with your other household waste. Instead, it is your responsibility to dispose of your waste equipment by handing it over to a designed collection point for the recycling of waste electrical and electronic equipment. The separate collection and recycling of your waste equipment at the time of disposal will help to conserve natural resources and ensure that it is recycled in a manner that protects human health and the environment. For more information about where you can drop off your waste equipment for recycling, please contact your local city office, your household waste disposal service, or the shop where you purchased the product.

---

**CAUTION:** The LaCinema HD Connect's warranty may be void as a result of the failure to respect the precautions listed above.

---

## Health and Safety Precautions

- Only qualified persons are authorized to carry out maintenance on this device.
  - Read this User Manual carefully and follow the correct procedure when setting up the device.
  - Do not open a disk drive or attempt to disassemble or modify it. Never insert any metallic object into the drive to avoid any risk of electrical shock, fire, short-circuiting or dangerous emissions. The disk drives shipped with your LaCinema HD Connect contain no user-serviceable parts. If it appears to be malfunctioning, have it inspected by a qualified LaCie Technical Support representative.
  - Never expose your device to rain, or use it near water, or in damp or wet conditions. Never place objects containing liquids on the LaCinema HD Connect, as they may spill into its openings. Doing so increases the risk of electrical shock, short-circuiting, fire or personal injury.
- 
- Make sure that the computer and LaCinema HD Connect are electrically grounded. If the devices are not grounded, there is an increased risk of electrical shock. Power requirements 100-240 V~, 1.5 A, 60-50 Hz, (Supply voltage fluctuations not exceeding  $\pm 10\%$  of the nominal, transient over-voltages according to over-voltage category II).
- 

## General Use Precautions

- Do not expose the LaCinema HD Connect to temperatures outside the range of 5° C to 30° C (41° F to 86° F); or to operational humidity beyond 5-80%, non-condensing, or non-operating humidity beyond 10-90%, non-condensing. Doing so may damage the LaCinema HD Connect or disfigure its casing. Avoid placing your LaCinema HD Connect near a source of heat or exposing it to sunlight (even through a window). Inversely, placing your LaCinema HD Connect in an environment that is too cold or humid may damage the unit.
  - Always unplug the LaCinema HD Connect from the electrical outlet if there is a risk of lightning or if it will be unused for an extended period of time. Otherwise, there is an increased risk of electrical shock, short-circuiting or fire.
  - Use only the power supply shipped with the device.
  - Do not place objects on top of the LaCinema HD Connect or use excessive force on it.
  - Never use excessive force on your LaCinema HD Connect. If you detect a problem, see the Troubleshooting section in this manual.
- 

**CAUTION:** A shielded-type power cord is required in order to meet FCC emission limits and also to prevent interference to the nearby radio and television reception. It is essential that only the supplied power cord be used.

---

## Operating Environment Temperatures

- Do not expose the LaCinema HD Connect to temperatures outside the range of 5° C to 30° C (41° F to 86° F). As high end audio/video appliance, the LaCinema HD Connect has been designed with an efficient ventilation system. Allow 5 cm of clearance for airflow on all sides of the LaCinema HD Connect to prevent overheating. See [Fig. 01](#).
- Do not stack the LaCinema HD Connect on or below another audio/video appliance such as a TV, VCR or DVD player. Other audio/video appliances require sufficient airflow and carry the same precautions of use. See [Fig. 02](#) and [Fig. 03](#).

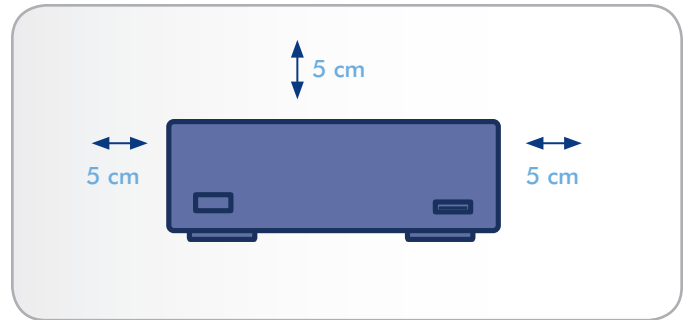

Fig. 01

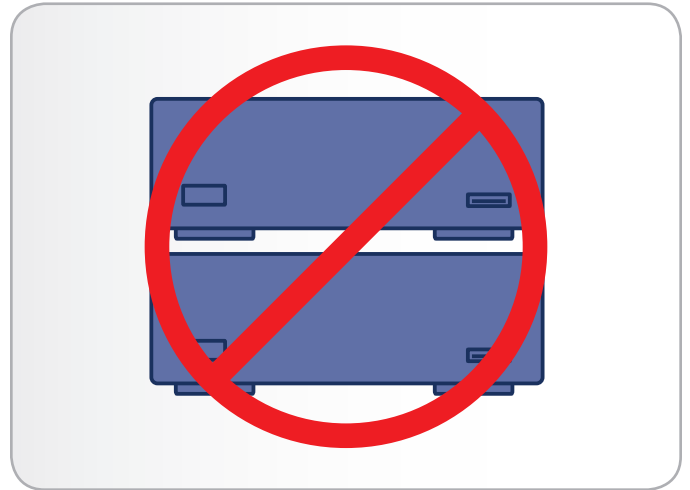

Fig. 02

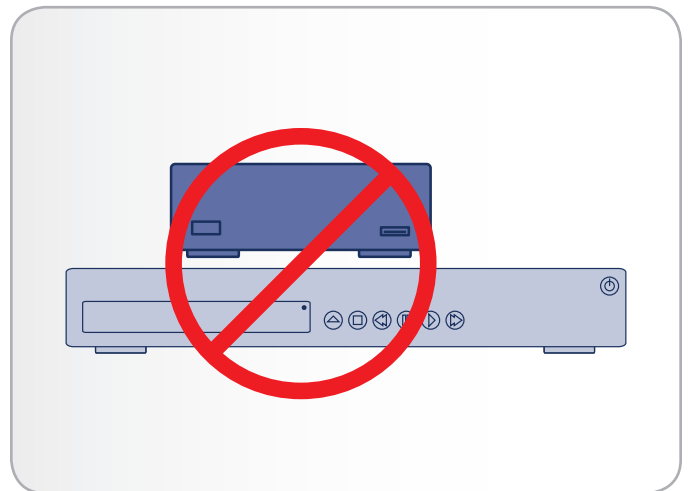

Fig. 03

## 1. Introduction

Congratulations on the purchase of your new LaCinema HD Connect! The LaCinema HD Connect plugs directly into a wide array of audio/visual equipment for instant playback of stored home movies, music or photos. And with high-quality video and quality audio, there's no compromise on performance.

To get started, simply connect the LaCinema HD Connect to your TV and use the included remote to easily navigate through the menus, called **Spaces**, to listen to music, view photos or watch High definition movies.

The LaCinema HD Connect allows you to choose from MPG, AVI, MP4, MKV, WMV, ISO, VOB, IFO, ASF, TS, TP, TRP, MTS, M2TS, and DAT video formats for easy playback.

### Quick Links

#### Click a topic:

- Setting Up: Connecting to TV & Network
- Setting Up: Connecting USB Hard Drive
- Playing Multimedia Files



## 1.1. Minimum System Requirements

### 1.1.1. Windows Users

- 500MHz Intel Pentium II processor or later
  - Windows XP, Vista, or Windows 7
  - 256MB RAM
  - USB interface port
  - Internet connection (for downloading updates)
- 

### 1.1.2. Mac Users

- G5 or later, or Intel Core Duo
  - Mac OS X 10.4.9
  - 256MB RAM
  - USB interface port
  - Internet connection (for downloading updates)
-

## 1.2. Supported Formats

Video Codecs		
■ MPEG-1	■ Xvid	
■ MPEG-2 / HD	■ H.264 HD	
■ MPEG4	■ WMV9 HD	
■ DivX / HD	■ VC-1	
Video File Types (Containers)		
■ AVI	■ MOV	■ TRP
■ MP4	■ MPEG	■ M2TS
■ MKV	■ VOB	■ DVR-MS
■ WMV	■ ASF	■ ISO*
■ DivX	■ TS	■ Video_TS*
■ DAT	■ TP	
External Hard Drive File Systems		
■ NTFS	■ FAT32 (MS-DOS)	■ HFS+ (not Journaled)
Subtitles		
■ SRT	■ SSA	■ SUB
■ SMI	■ PSB	■ ASS
Audio File Types (Containers)		
■ MP3	■ AAC**	■ AC3
■ WMA	■ OGG	■ MP4
■ WAV/PMC/LPMC	■ FLAC	■ MKA
Playlists		
■ M3U	■ PLS	■ WPL
Dolby Digital / DTS		
■ 2 channels decode and 5.1 downmixing to stereo		
■ Multichannel decoding via optical S/PDIF and HDMI to home amplifier		

### Photo File Types

■ PNG	■ BMP	■ TIFF
■ GIF	■ JPEG (except Progressive JPEG)	

### Video Outputs

■ Composite (CVBS)	■ HDMI 1.3
--------------------	------------

### Audio Outputs

■ Optical	■ Stereo
-----------	----------

\* DVD Video function is supported via VOB / IFO (Video\_TS folder). If the drive is formatted in FAT32, DVD ISO file size cannot exceed 4GB due to file system format limitation.

\*\* Supports iTunes encoded (m4a).

\*\*\* For audio with more than 2 channels, connect the product to a digital home receiver. The audio is passed through the coaxial connection (see section 3.1.3. [Optical Audio \(S/PDIF\) Connection](#)).

---

**TECHNICAL NOTE:** A container, such as AVI or MOV, is a file format that defines how the data stream is stored. They contain data that has been compressed using a codec. For a file to play properly on your LaCinema HD Connect, both its codec and container type must be supported.

---



---

**TECHNICAL NOTE:** You can download third party applications that will help you to identify a file's codec, container, and other information. LaCie suggests the free application Media Info.

---

### 1.3. Box Content

1. LaCinema HD Connect
2. Remote control
3. 2 x AAA batteries
4. Video composite + stereo cable
5. Ethernet cable
6. External power supply
7. Quick Install Guide
8. Utilities CD-ROM (includes User Manual and Packet Video TwonkyMedia Server software for Mac and PC)

---

**IMPORTANT INFO:** Please save your packaging. In the event that the drive should need to be repaired or serviced, it must be returned in its original packaging.

---

### 1.4. Languages

#### Supported Languages

- |                        |                         |
|------------------------|-------------------------|
| ❖ Chinese (Simplified) | ❖ Chinese (Traditional) |
| ❖ Dutch                | ❖ English               |
| ❖ French               | ❖ German                |
| ❖ Greek                | ❖ Italian               |
| ❖ Japanese             | ❖ Korean                |
| ❖ Polish               | ❖ Portuguese            |
| ❖ Russian              | ❖ Spanish               |
| ❖ Swedish              |                         |

Please check the LaCie website for a complete list of supported languages.

---

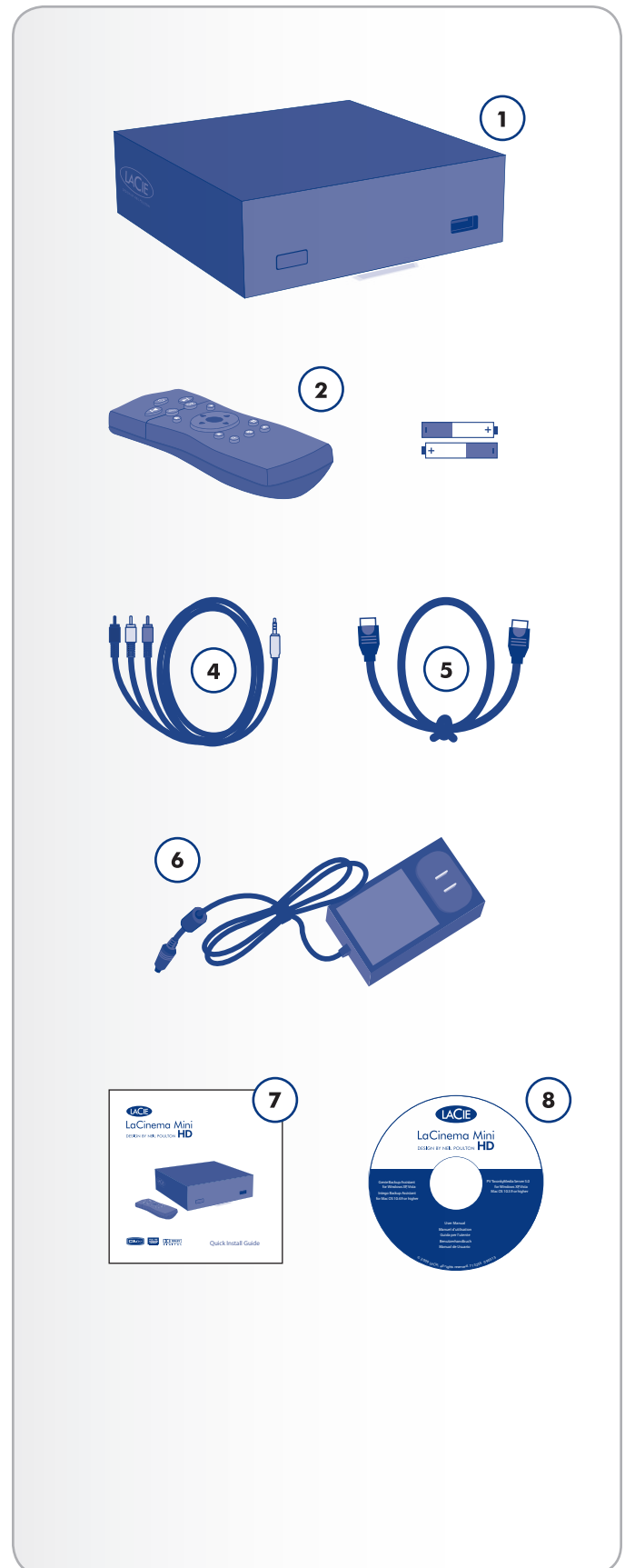

## 1.5. Views of the LaCinema HD Connect

### 1.5.1. Front View

1. Infrared receiver – Receives the infrared signal from the remote control. Make sure the receiver is not obstructed.  
Stand-by button – By default, pushing this button puts the drive into stand-by mode or wakes it from standby (this behavior can be modified; see [1.7. Power Management](#) for more details)
2. Blue status light – If the drive is connected to a TV or computer, this light will be on. It will turn off when disconnected.
3. USB port (connect disk) – Connect a USB disk, digital camera, or card reader to access its multimedia files directly from your TV.

### 1.5.2. Rear View

1. USB 2.0 host – Connect a USB disk, digital camera, or card reader
2. Ethernet connector – Connect to your home network via an Ethernet cable to your router
3. Optical audio out – Connect to digital home amplifier
4. Video composite + stereo connector – Connect to any TV (CRT)
5. HDMI – Connect to a High Definition flat screen TV or video projector
6. Power connector – Must be connected when the drive is attached to a TV. When connected to a computer, the drive is bus powered through the USB connection, but if your computer does not provide enough power through the USB port, connect the power supply.

**CAUTION:** Do not stack another electronic device on or below the LaCinema HD Connect or place it in an enclosed area to avoid performance and overheating issues ([Fig. 06](#)).

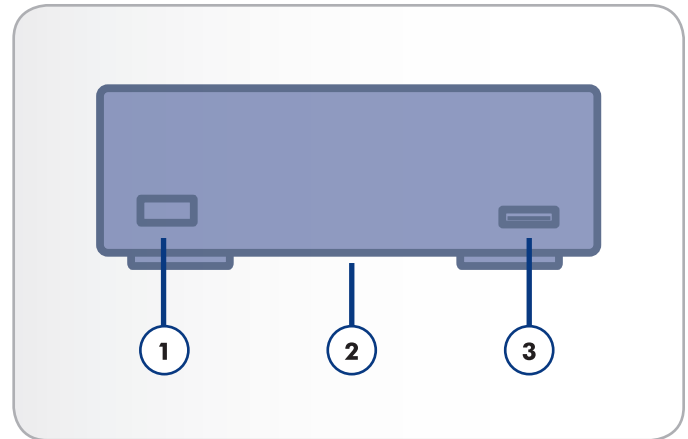

Fig. 04

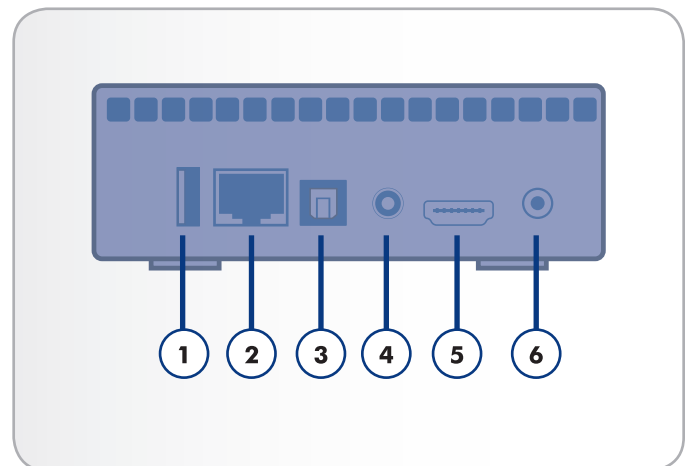

Fig. 05



Fig. 06

## 1.6. Cables and Connectors

### 1.6.1. A/V (Audio/Video) Cables

These cables provide the audio and video signals to your stereo and TV. The LaCinema HD Connect supports the following standards:

1. Composite video + stereo audio – This is the most standard video connection (yellow) as well as left (white) and right (red) stereo audio inputs. If your TV only has a SCART connector, you can purchase a SCART-Composite adapter from your local retailer.
2. HDMI (High-Definition Multimedia Interface) – This is the best audio/video method for connecting the LaCinema HD Connect to HDTVs (not included).
3. Optical Audio (S/PDIF) (not included) – This connection allows you to connect your LaCinema HD Connect to a digital amplifier.

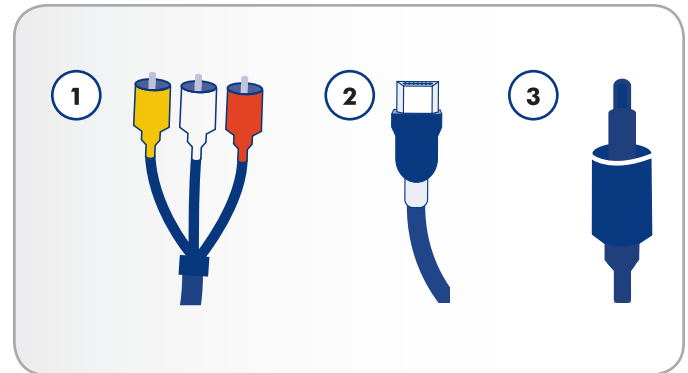

Fig. 07

	Connection	Maximum Resolution
High Definition	HDMI	1080p
Standard Definition	Composite	576p



## 1.7. Power Management

LaCinema Mini HD Connect will start as soon as the power supply is connected.

### Power modes

By default, the LaCinema HD Connect is set to **Instant ON** mode, which means that when you press the power button on the remote control (Fig. 08) or the standby button on the front of the drive (Fig. 09), the user interface will turn off but the drive will remain available for network connections (including file and UPnP/DLNA server features).

Alternatively, you can put the drive in low power mode from the user interface. Go to the Shut Down menu in the Settings Space and choose **Shut Down**. This mode will turn off the user interface, attached hard disk (if connected), and network services (including UPnP/DLNA server features).

### Disconnecting the power supply

Always enter low power mode by navigating to the shutdown menu in the Settings Space before disconnecting the power supply. This will prevent hard disk corruption.

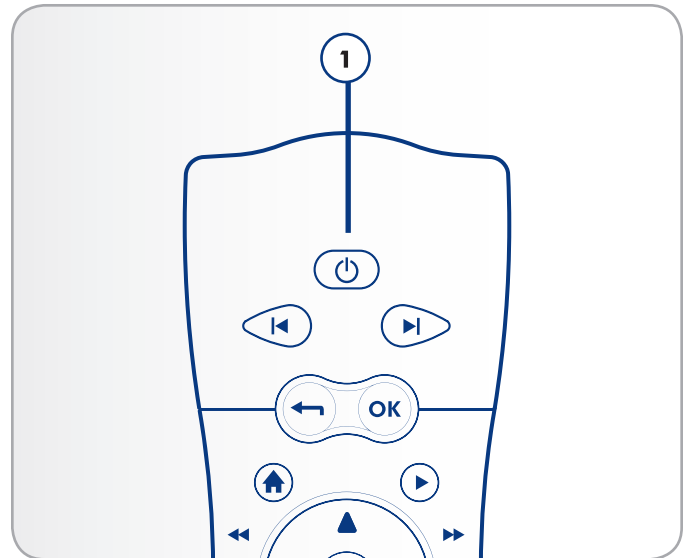

Fig. 08

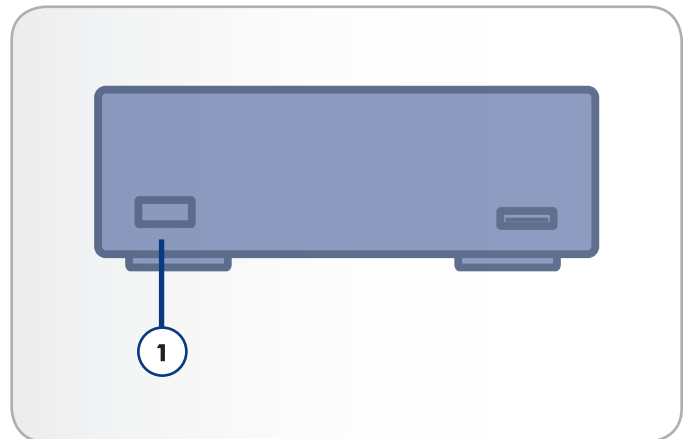

Fig. 09

## 2. Using the Remote Control

Some of the buttons of the remote control have different functions or no function at all depending on the type of file you are viewing. This chapter discusses the button functions for each type of file (movies, photos and music) and battery installation.

### 2.1. Battery Installation

The remote control uses two AAA batteries. The batteries are not pre-installed, so you will need to install them before you can use the remote control.

#### To install the batteries:

1. Remove the battery compartment cover (Fig. 10).
2. Load the batteries onto the battery compartment. Position the batteries so that the "+" symbols on the batteries face the same direction as the "+" symbols on the battery compartment.
3. Slide the battery compartment cover back into the remote.

---

**IMPORTANT INFO:** If you will not be using the remote control for an extended period of time, LaCie recommends that you remove the batteries.

---

---

**IMPORTANT INFO:** The remote control must be pointed at the infrared receiver on the LaCinema HD Connect (Fig. 11) no further away than of 23 feet (7 meters).

---

---

**IMPORTANT INFO:** When replacing batteries, please do not dispose of the used batteries with your normal household waste. Dispose of them by handing them over to a designed collection point for the recycling of waste electrical and electronic equipment.

---

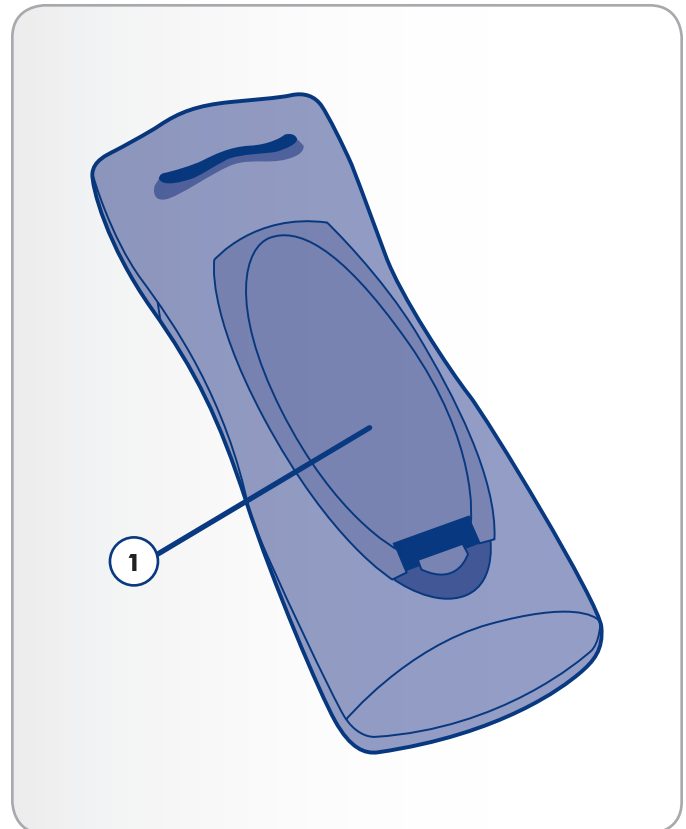

Fig. 10

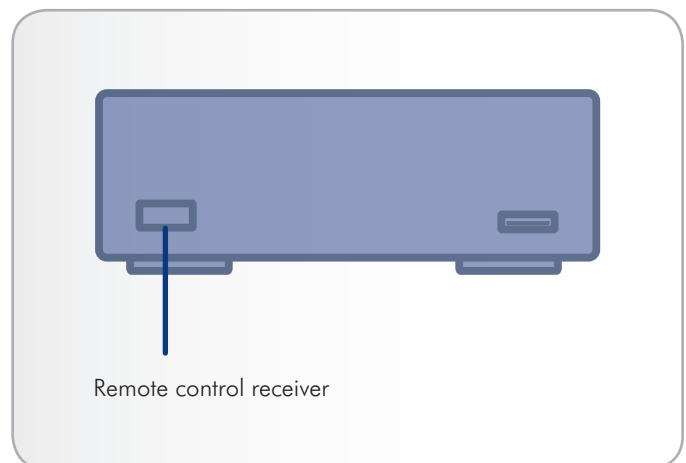

Fig. 11

## 2.2. Remote Control Key Index

The LaCinema HD Connect's remote control allows you to control the LaCinema HD Connect while its connected to your TV or home theatre center.

Button
1. Infrared emitter
2. Stand-by
3. Previous track
4. Next track
5. Back (previous screen)
6. Select
7. Home menu
8. Play
9. Menu up
10. Left/rewind
11. Right/fast forward
12. Menu down
13. Stop
14. Pause
15. Access search menu
16. Option/info menu
17. Safely eject USB disk

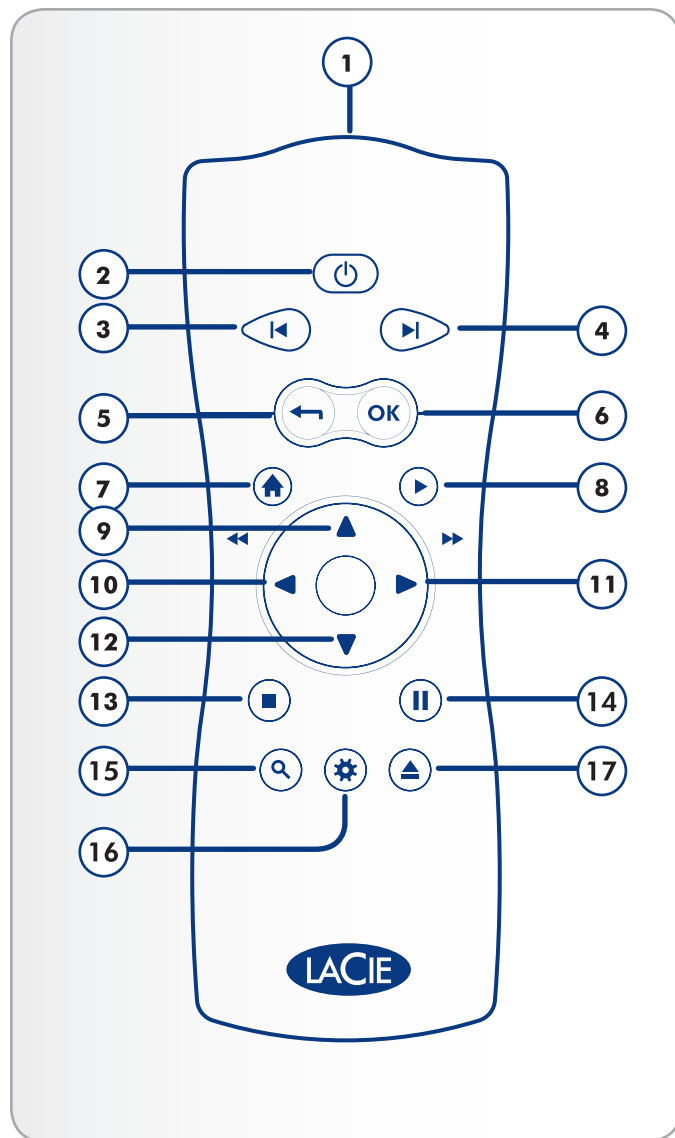

Fig. 12

### 2.2.1. Important Button Details

1. **OK:** This button allows you to confirm a selection.
2. **Return:** Press this button to return to the previous menu.
3. **Settings button:** This button is used to display the available settings or actions in the different media spaces.

During playback, pressing this button will bring up a contextual menu with adjustable settings.

4. **Eject button:** This button will safely eject an attached USB drive. Make sure to press this button before disconnecting the USB drive to avoid file system corruption that could make your disk unusable (see [4.6. Safely Disconnect Hard Drive from LaCinema HD Connect](#)).

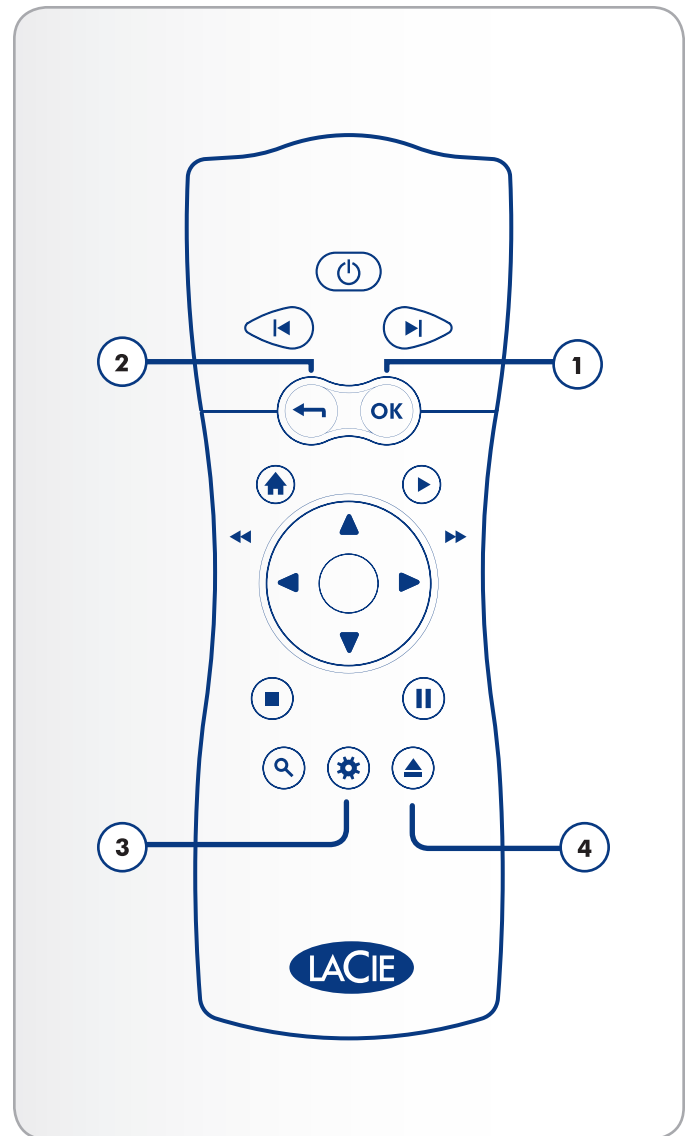

Fig. 13

## 3. Setting Up: Connecting to TV & Network

This chapter explains how to connect your LaCinema HD Connect to your television and network. If you would also like to connect a USB hard drive in order to play its files on the TV, see section 4. [Setting Up: Connecting USB Hard Drive](#).

This section consists of these steps:

3.1. STEP 1: Connect HDMI or Composite Cables

3.2. STEP 2: Connect to the Network

3.3. STEP 3: Connect the Power Supply

3.4. STEP 4: Complete the Installation Wizard

### 3.1. STEP 1: Connect HDMI or Composite Cables

The LaCinema HD Connect supports different ways of connecting to televisions. From the following methods, choose the setup that matches the ports on your television or receiver:

- HDMI (section [3.1.1. HDMI \(High-Definition\) Connection](#))
- Composite (section [3.1.2. Composite Video & Stereo Audio Connection](#))

In each of the above connection methods, it is possible to connect the LaCinema HD Connect to home theater systems by plugging the S/PDIF cable (not included) to your digital amplifier via the digital optical audio connector (see section [3.1.3. Optical Audio \(S/PDIF\) Connection](#) for details). The chart at right illustrates the qualities made possible by the different connection methods.

[continued on the next page >>](#)

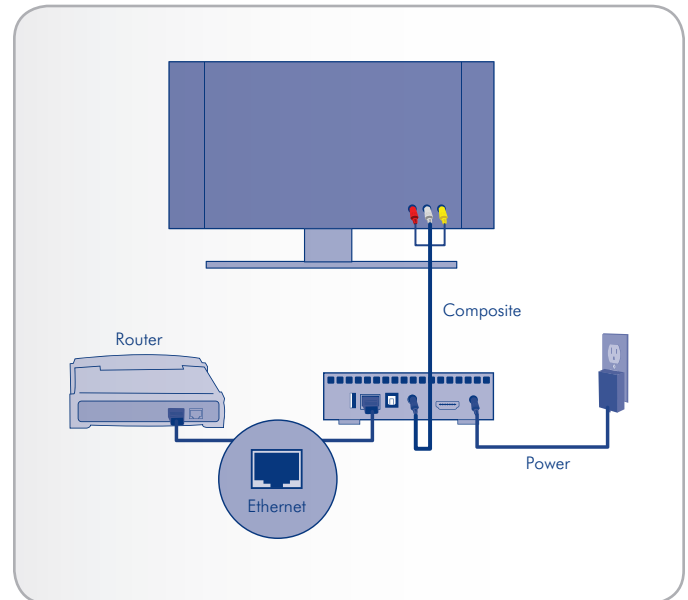

Fig. 14

	Connection	Maximum Resolution
High Definition	HDMI	1080p
Standard Definition	Composite	576p

**TECHNICAL NOTE:** The connectors on the rear of your TV may not appear exactly as shown in the following pages. Please read the labels next to the connectors carefully to ensure correct connections.

### 3.1.1. HDMI (High-Definition) Connection

1. Connect an HDMI cable (not included) to your television's HDMI port and to the corresponding port on the LaCinema HD Connect (Fig. 15).
2. Move on to the next step, 3.2. STEP 2: Connect to the Network.

### 3.1.2. Composite Video & Stereo Audio Connection

1. Connect the three tips of the composite video and stereo cable to the proper ports on your television and to the corresponding port on the LaCinema HD Connect (Fig. 16).
2. Move on to the next step, 3.2. STEP 2: Connect to the Network.

---

**IMPORTANT INFO:** Before connecting either of these cables, make sure you TV is turned off.

---

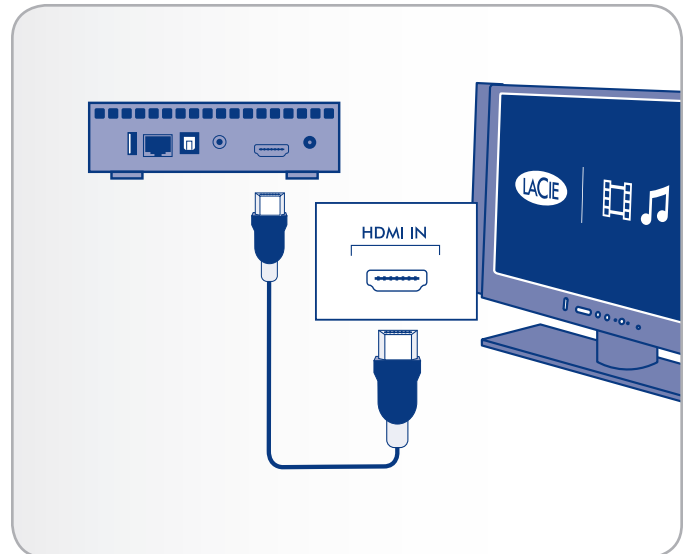

Fig. 15 - HDMI connection

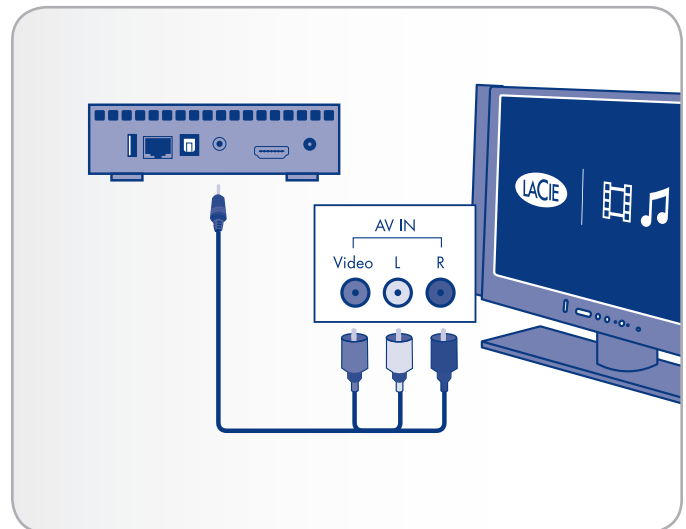

Fig. 16 - Composite connection

### 3.1.3. Optical Audio (S/PDIF) Connection

In each of the above connection methods, it is possible to connect the LaCinema HD Connect to home theater systems by plugging the S/PDIF cable (not included) into your digital amplifier via the LaCinema HD Connect's digital optical audio connector.

---

**IMPORTANT INFO:** Before connecting the cable, power off your digital amplifier.

---

1. Connect one end of a S/PDIF cable to your digital amplifier (Fig. 17).
2. Connect the other end of the cable to the back of the LaCinema HD Connect.
3. Move on to the next step, [3.2. STEP 2: Connect to the Network](#).

---

**IMPORTANT INFO:** Once you connect the cable and finish the rest of the steps in this section, you must enable digital audio in [Settings > Audio Output](#) instead of the default stereo audio. See section [9.1. Settings: Audio/Video](#) (Fig. 18 and Fig. 19).

---

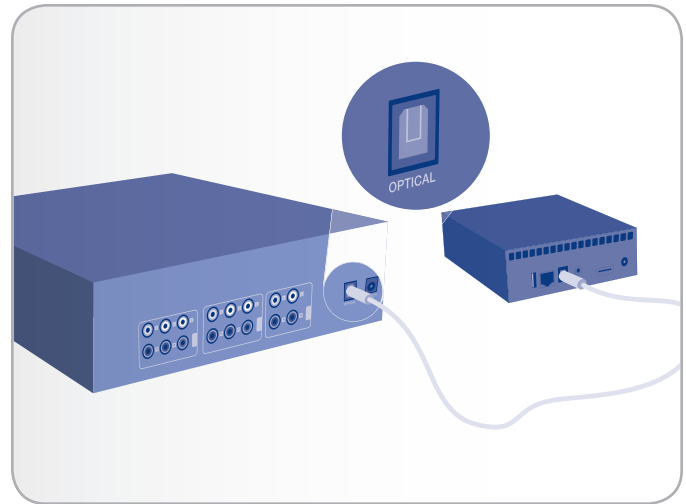

Fig. 17 - S/PDIF connection

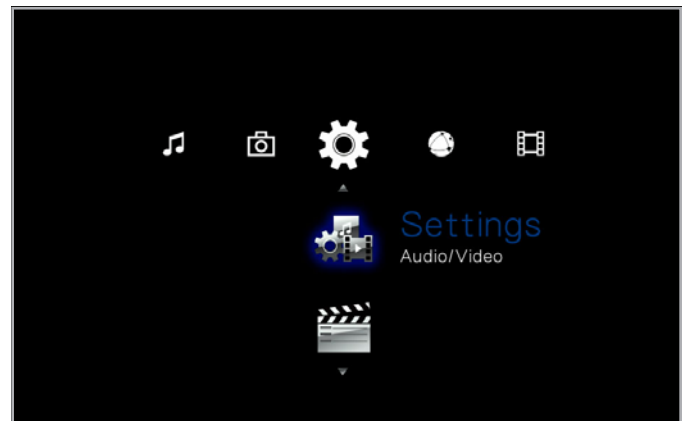

Fig. 18



Fig. 19

## 3.2. STEP 2: Connect to the Network

### Ethernet Connection

1. Connect the Ethernet cable to the Ethernet port on the back of the LaCinema HD Connect (Fig. 20).
2. Connect the other end of the Ethernet cable into an available Ethernet LAN (local area network) port on your router or hub (refer to your router or hub's documentation if necessary).

### WiFi Connection

1. Connect the WiFi dongle (sold separately) to either the front or rear USB port (Fig. 21).

Now move on to the next step, [3.3. STEP 3: Connect the Power Supply](#).

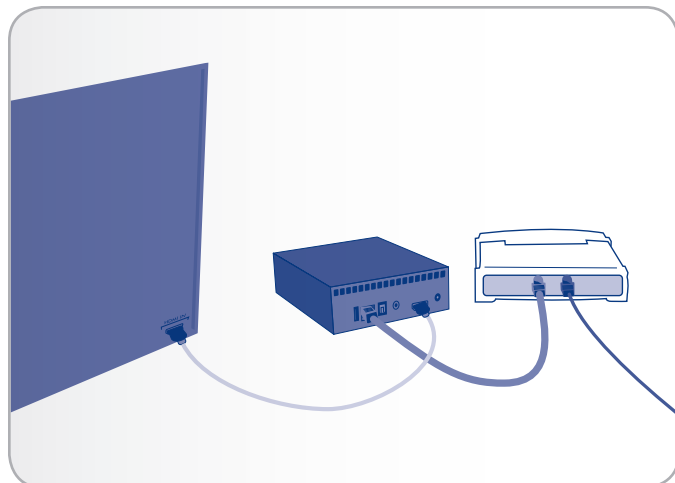

Fig. 20

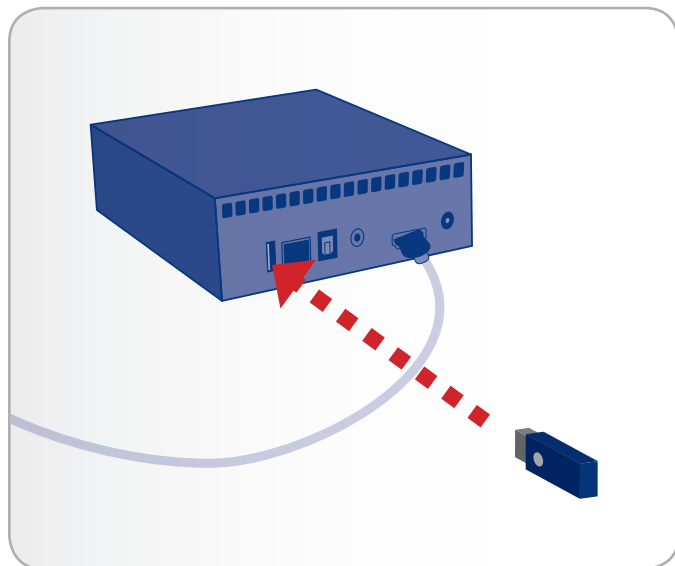

Fig. 21



### 3.3. STEP 3: Connect the Power Supply

**IMPORTANT INFO:** If your power supply cable is already connected, turn on your TV and then skip to [3.4. STEP 4: Complete the Installation Wizard](#).

1. Plug one end of the power adapter cord into the back of LaCinema HD Connect and the other end into a power outlet ([Fig. 22](#)).
2. Turn on your television.

**TECHNICAL NOTE:** If you don't see the loading screen, adjust the video input on your TV to match the type of video cable you connected above (either HDMI or composite) ([Fig. 23](#)).

3. Move on to the next step, [3.4. STEP 4: Complete the Installation Wizard](#).

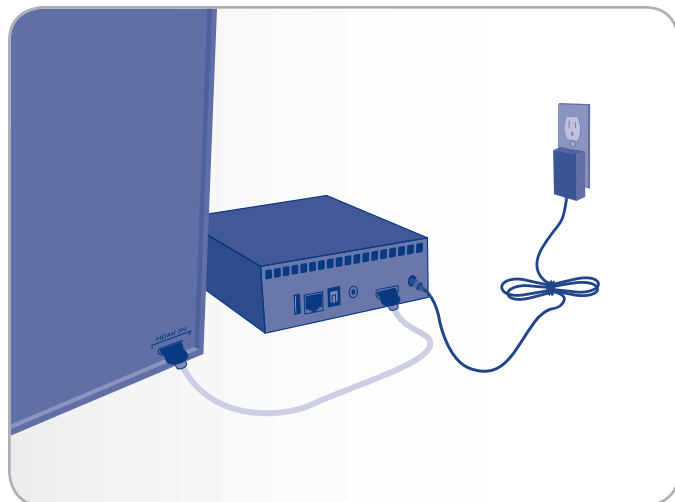

Fig. 22

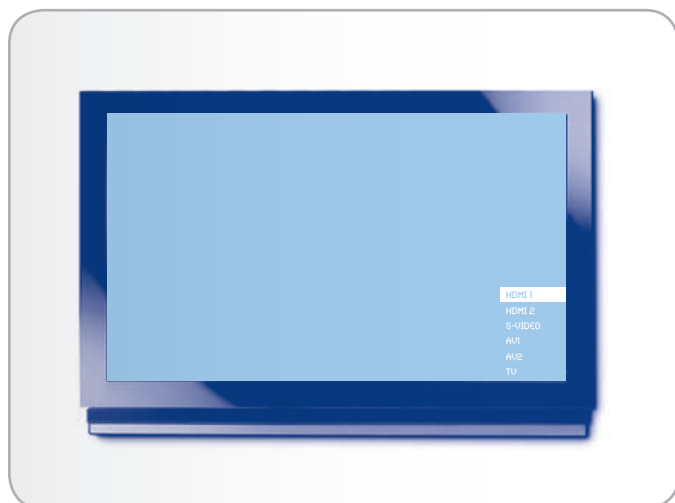

Fig. 23 \*

\* Screen may look different on your TV.

### 3.4. STEP 4: Complete the Installation Wizard

The first time you turn on the LaCinema HD Connect, a wizard appears to help you configure your settings. The wizard appears only the first time you turn on the LaCinema HD Connect unless you have reset drive.

1. Make sure the LaCinema HD Connect is connected to the TV, the power supply has been connected, and the TV is turned on.
2. A startup screen will appear during product initialization.
3. Select your language using the **Up ▲** and **Down ▼** buttons and pushing the **Right ►** or **OK** button to confirm (Fig. 24).
4. In the next screen, click **Next** (Fig. 25).
5. Select your TV's physical aspect ratio (4:3 or 16:9) and click **Next** (Fig. 26).

[continued on the next page >>](#)

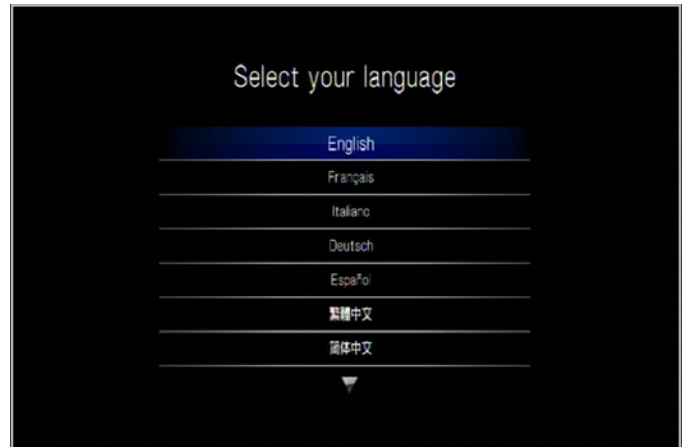

Fig. 24

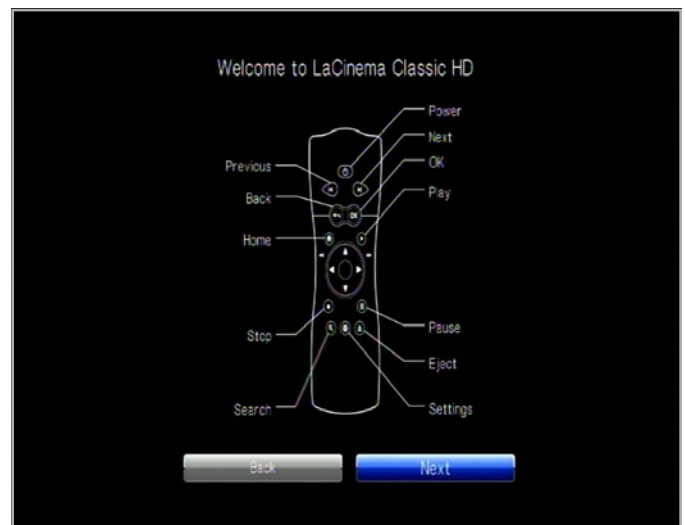

Fig. 25



Fig. 26

6. Select the type of network connection (Wireless or Ethernet) and click **Next**, or click **Skip** (Fig. 27).

---

**IMPORTANT INFO:** Make sure you have connected either the Ethernet cable or a WiFi dongle (sold separately) as described in section 3.2. *STEP 2: Connect to the Network.*

---

7. Select whether your network is assigned an IP address automatically or if you want to assign a static IP and click **Next** (Fig. 28).
8. If you selected a wired network, setup is finished. If you choose wireless:
  - a. Select **Wireless Favorites** from the menu.
  - b. Choose your wireless network and press **Connect Now**.
  - c. You can configure multiple wireless networks from this page. To set one network as preferred, and therefore the server that the LaCinema HD Connect will connect to automatically, select the network and select the **Favorites** button (Fig. 29).
  - d. When you see the successful connection icon to the right of the network listing, you can click the **Close** button.
9. Setup is finished. For further details, move on to [5. Playing Multimedia Files](#).

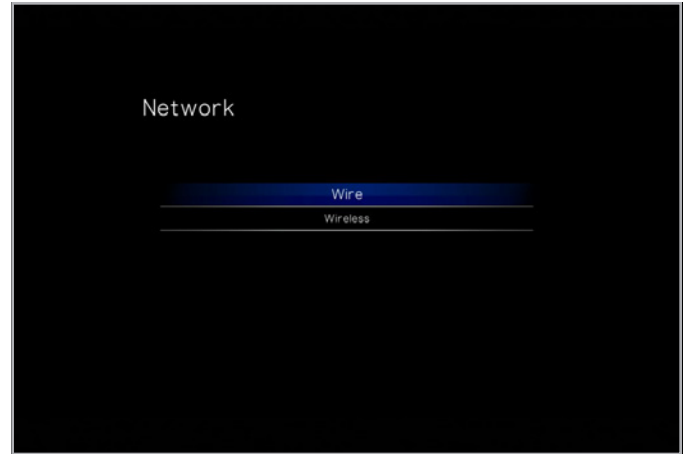

Fig. 27



Fig. 28



Fig. 29

## 4. Setting Up: Connecting USB Hard Drive

The LaCinema HD Connect can play files located either on network sources (computers, network-attached storage, DLNA/UPnP devices, etc.), or it can play files located on attached external USB hard drive. This chapter will explain how to transfer files from your computer to your external hard drive, then how to disconnect the hard drive from your computer and connect it to the LaCinema HD Connect for playback on your TV (*Fig. 30*).

### 4.1. About External USB Hard Drives

#### 4.1.1. Compatibility

In addition to hard disks, you can also connect card readers, digital cameras, or digital camcorders with USB Mass storage support.

Hard drives with the following file system formats are supported: FAT32, NTFS, HFS+/Mac OS Extended (non-journaled), and Linux file systems.

---

**IMPORTANT INFO:** External USB hard drives formatted in HFS+ (journaled) are not compatible.

---

To reformat in compatible file system, see [8. Formatting External USB Hard Drives](#).

---

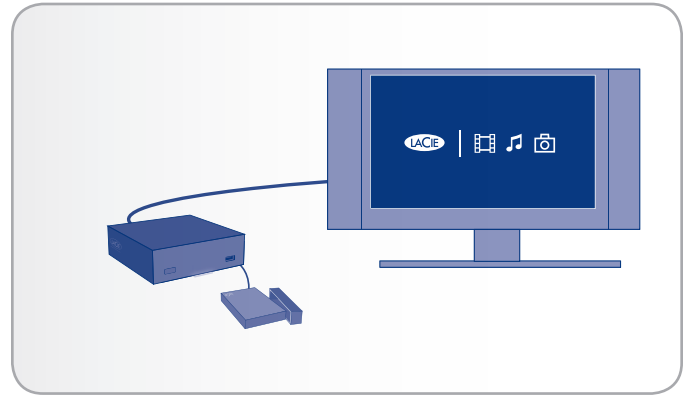

Fig. 30

## 4.2. STEP 1: Connect Hard Drive to Computer

1. Connect the hard drive's power cable (if it has one).
2. Connect the hard drive's USB cable to the drive and to your computer (Fig. 31). If you're using a USB flash drive, connect it directly to your computer's USB port.
3. Turn on the hard drive (if it has a power button).

Move on to the next step, [4.3. STEP 2: Load Files](#).

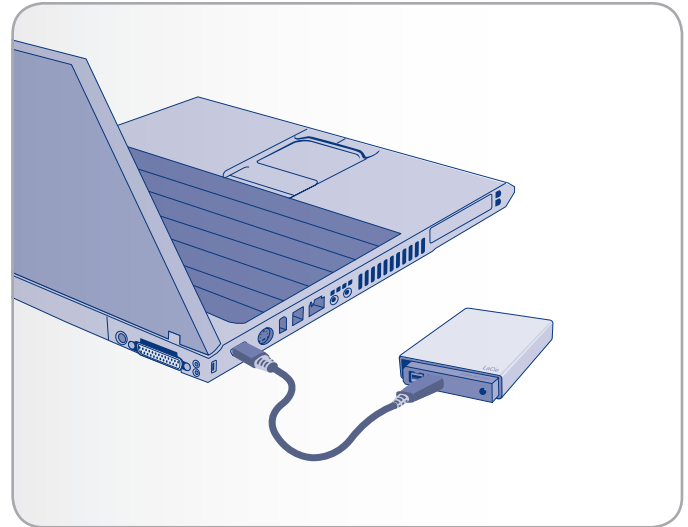

Fig. 31

## 4.3. STEP 2: Load Files

1. The drive will mount on your Desktop (Mac users), in My Computer (Windows XP users) or Computer (Windows 7 or Vista users).
2. Drag files from your computer's hard drive to the external hard drive (see Fig. 32 for Mac and Fig. 33 for Windows).

Move on to the next step, [4.4. STEP 3: Safely Disconnect Hard Drive from Computer](#).

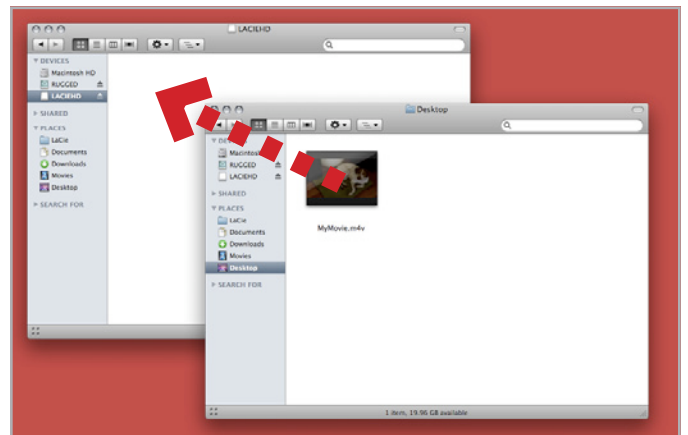

Fig. 32 - Mac users

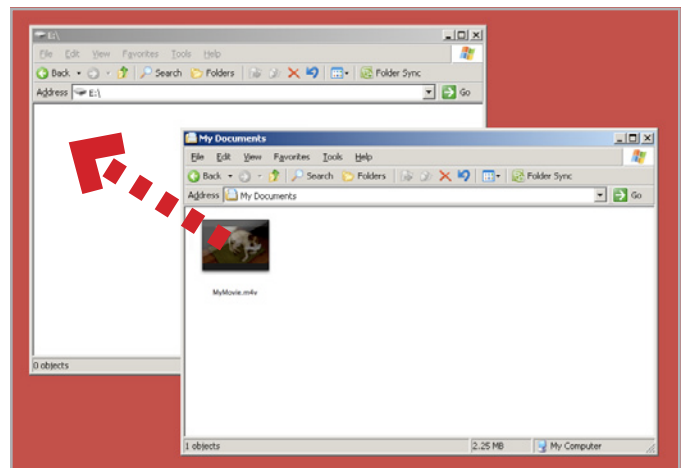

Fig. 33 - Windows users

## 4.4. STEP 3: Safely Disconnect Hard Drive from Computer

USB external devices feature “plug & play” connectivity, which means that your drive can be connected and disconnected while the computer is running. To prevent failures, however, it is important to follow these steps when disconnecting your drive from your computer.

### Windows Users

From the System Tray (located in the lower right-hand side of your screen), click the Eject icon (a small green arrow over a hardware image) (Fig. 34).

A message will appear, listing the devices the Eject icon controls (it should say, “Safely remove...”). Click on the LaCie hard disk in this prompt.

This message will appear: “Safe to Remove Hardware” (or similar). It is now safe to disconnect the device.

### Mac Users

Drag the hard disk icon to the trash (Fig. 35).

When the icon disappears from the desktop, the drive can be disconnected.

Move on to the next step, [4.5. STEP 4: Connect Hard Drive to LaCinema HD Connect](#).

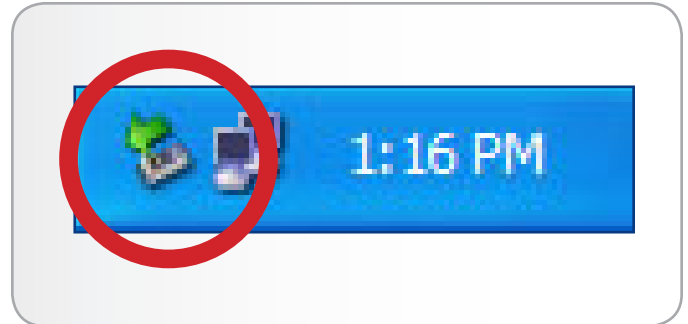

Fig. 34 - Windows users



Fig. 35 - Mac users

## 4.5. STEP 4: Connect Hard Drive to LaCinema HD Connect

Once you loaded multimedia files onto your external hard drive and disconnected it from your computer, you are ready to connect it to the LaCinema HD Connect. If you haven't already connect the LaCinema HD Connect to your TV and network, first follow the steps outlined in [3. Setting Up: Connecting to TV & Network](#) before attaching the external hard drive to the LaCinema HD Connect.

1. Connect the hard drive's power cable (if it has one).
2. Connect the hard drive's USB cable to the drive and to the front or rear USB port on the LaCinema HD Connect ([Fig. 36](#) - left). If you're using a USB flash drive, connect it directly to one of the LaCinema HD Connect's USB ports ([Fig. 36](#) - right).
3. Turn on the hard drive (if it has a power button).
4. You're done! Use the remote control to navigate to one of the Media Spaces (Movies, Photos, or Music). Files located on the external USB hard drive can be accessed either according to the file type (i.e. Music Space for music files) or under the **USB1** heading ([Fig. 37](#)).

For more details on playing files on your TV, see [5. Playing Multimedia Files](#).

---

**IMPORTANT INFO:** Make sure to properly disconnect your external hard drive from the LaCinema HD Connect to avoid damaging its file system.

---

## 4.6. Safely Disconnect Hard Drive from LaCinema HD Connect

In order to avoid damaging your external hard drive's file system, it is important to properly disconnect it from the LaCinema HD Connect.

To do so, click the  (Eject) button on the remote control, confirm ([Fig. 38](#)), and then disconnect the drive.

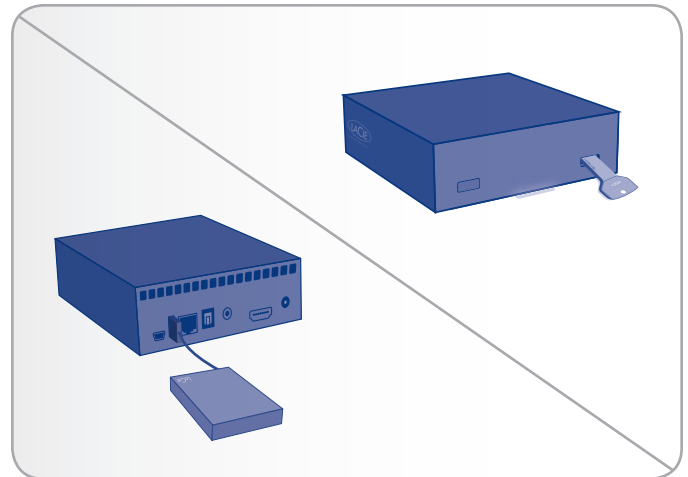

Fig. 36

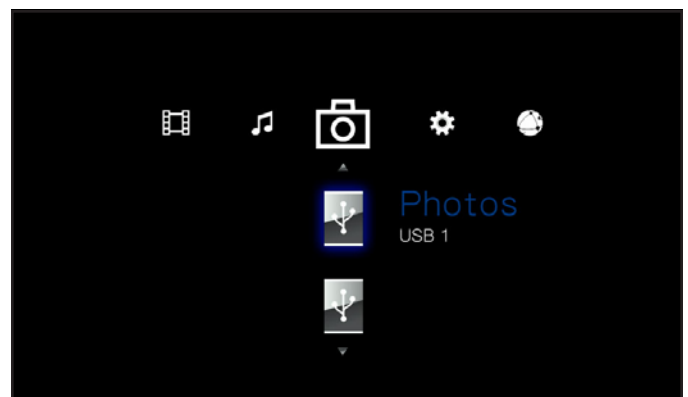

Fig. 37

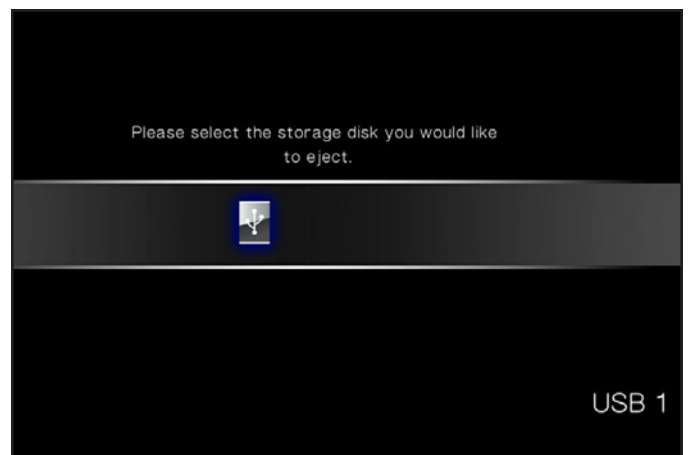

Fig. 38

## 5. Playing Multimedia Files

This chapter explains how to use the interface and to play files located either on an attached USB hard drive or network source.

To access your files, use the remote control to browse through the different media spaces – [Movie](#), [Photo](#), [Music](#), or [Network](#) (Fig. 39).

- By default, files located on a connected external hard drive will be organized according to their folder structure. You can modify this so that they are organized according to file type (i.e. music files in the Music Space). To do this, navigate to [Settings Space](#) > [System](#) > [Content Aggregation](#) (Fig. 40) and select [On](#) (Fig. 41).
- If the file is stored on a connected network server, device, or computer, you can find the file in the Network Space (see [5.4. Network Space](#)).
- If the file is stored on a connected external hard drive, you can also find its files by navigating to the [Movie](#), [Photo](#), or [Music](#) space and then [USB1](#).

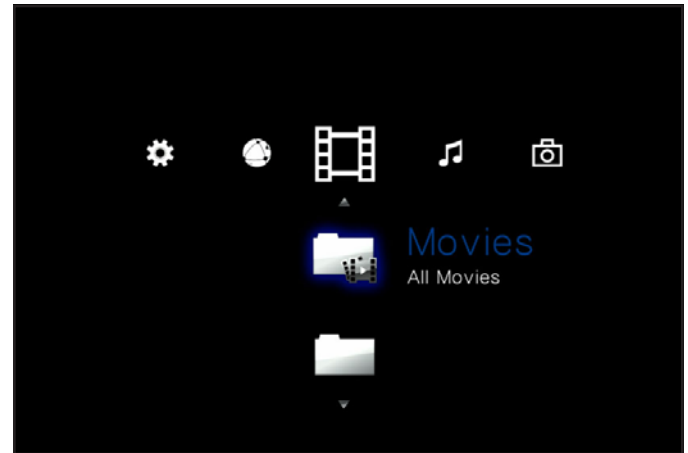

Fig. 39

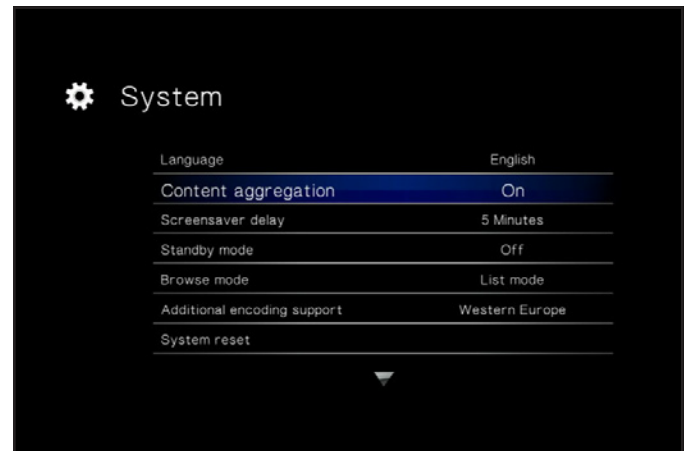

Fig. 40

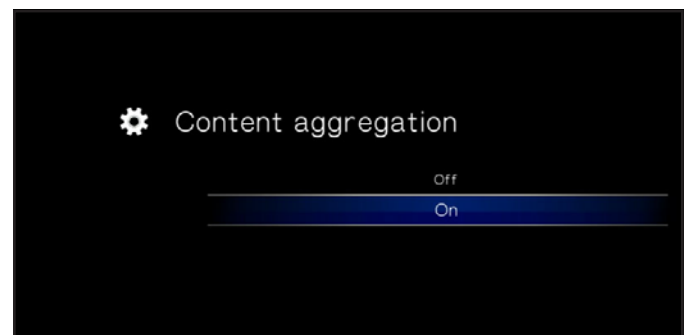

Fig. 41

File Type	Section
Movies	<a href="#">5.1. Movie Space</a>
Photos	<a href="#">5.2. Photos Space</a>
Music	<a href="#">5.3. Music Space</a>

File Location	Section
Connected USB hard drive	<a href="#">5.1. Movie Space</a>
	<a href="#">5.2. Photos Space</a>
	<a href="#">5.3. Music Space</a>
Network	<a href="#">5.4. Network Space</a>



## 5.1. Movie Space

Navigate to the Movies Space using the **Left** ◀ and **Right** ▶ buttons. Then use the **Up** ▲ and **Down** ▼ buttons to browse within the Movie Space (Fig. 42).

The Movie Space will display all of the supported video files that are accessible to the LaCinema HD Connect. Only files recognized as video files will be displayed. Music and Photo files will not be displayed.

- **All Movies:** Displays all available videos, sorted alphabetically
- **By Folder:** Displays videos according to the volume's folder structure, including files located on an external USB hard drive connected to the front USB port
- **Most recent:** Displays the most recently played videos only
- **USB1:** Displays movie files located on an external USB hard drive connected to the front or rear USB port (for details, refer to section 4. *Setting Up: Connecting USB Hard Drive*)

To load a movie, select the file you wish to play and press the **OK** button. A loading animation will appear while the it is being analyzed to ensure optimum playback experience.

---

**NOTE:** If you stop a film and then come back to it later, you will be asked if you want to play from where you left off or to start from the beginning.

---

---

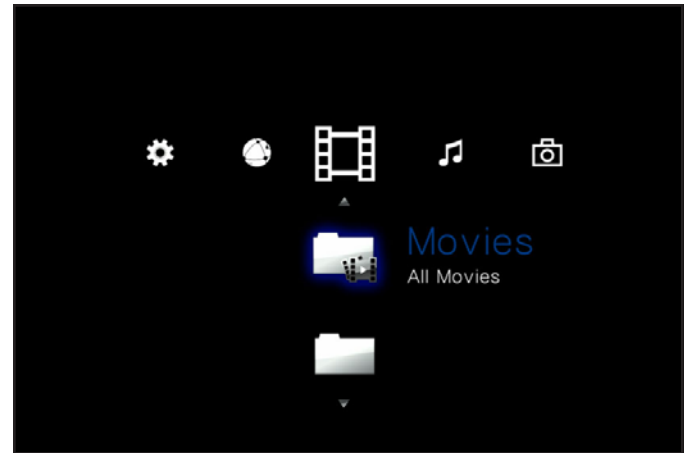





Fig. 42

### 5.1.1. Movie Space Options

While a movie is playing, you can adjust several playback parameters. Press the **Setup**  button to display or exit the on-screen menu, and use the **Left**  and **Right**  buttons to navigate to a setting and **OK** to enter the setting menu (see [Fig. 43](#) for reference). Once you've selected the option you want, click the **OK** button.

- 1. Audio Languages:** Select this option to modify the audio language (if alternates are available)
- 2. Subtitle:** Select this option to activate/change the subtitles (if are available)
- 3. Zoom In:** This feature allows you to zoom into a video. Once the feature has been selected, use the **Up** button to zoom in ([Fig. 44](#)).
- 4. Zoom Out:** To zoom out, select this icon and press the **Up** button.
- 5. Scroll:** If you have zoomed into a video, select this icon to scroll around the video. Use the direction buttons on your remote control ([Fig. 45](#)).

[continued on the next page >>](#)

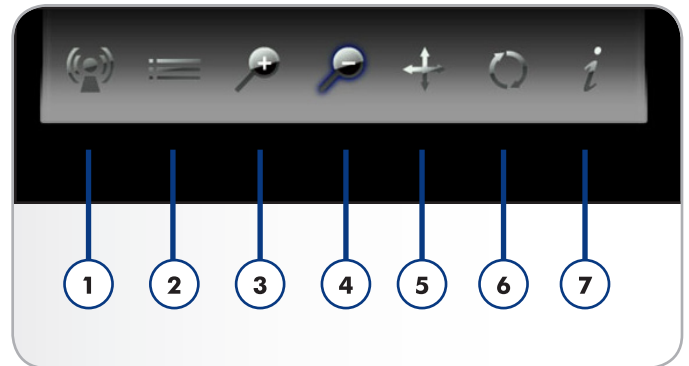

Fig. 43



Fig. 44

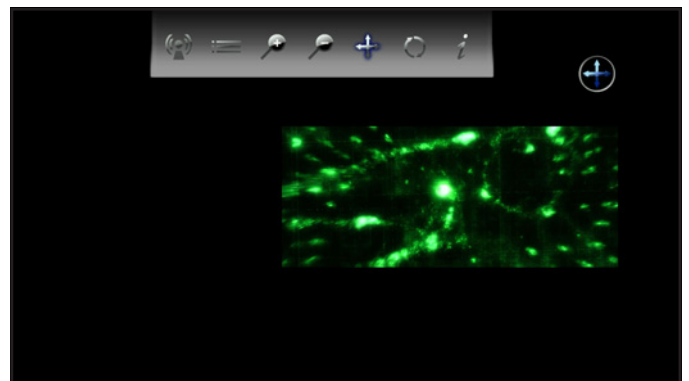



Fig. 45

**6. Change play mode:** By pressing the **Setup**  button you can adjust the play mode as follows:

- a. Normal (*Fig. 47*)
- b. Repeat one: The currently playing file will repeat continuously (*Fig. 48*)
- c. Repeat all: All files in the current folder will play in succession repeatedly (*Fig. 49*)

**7. Display info:** Click this button to display information about the currently playing file such as time remaining and time elapsed.

To exit the on-screen menu, click the **Setup**  button once again.

---

---

**NOTE:** You can pause the video while adjusting settings.

---

---

**NOTE:** If you stop a file, the settings will revert to the default when you reopen the file.

---

---

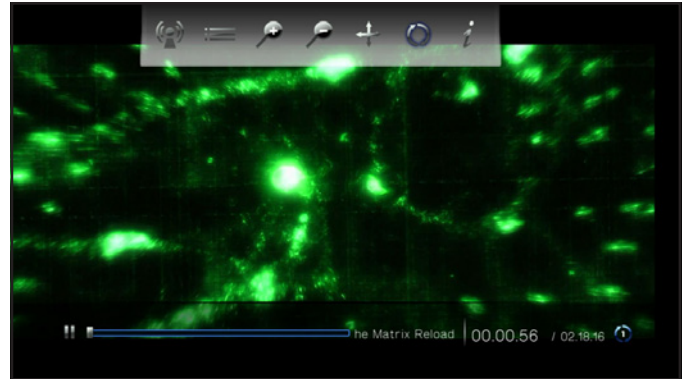

Fig. 46

---

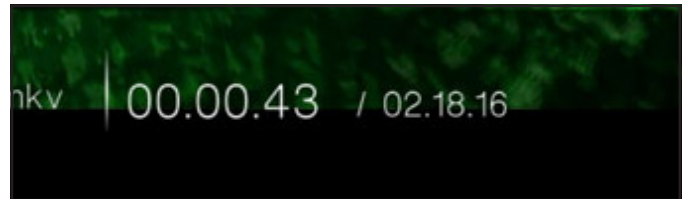

Fig. 47

---

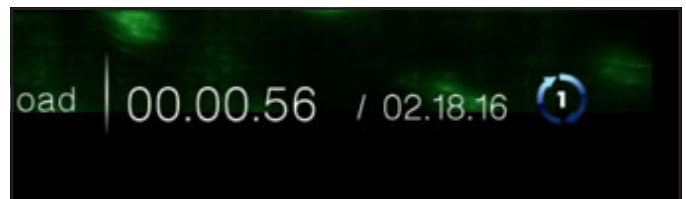

Fig. 48

---

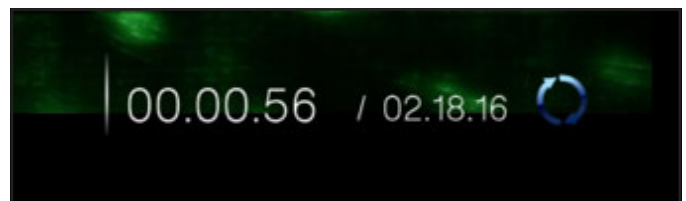

Fig. 49

---

## 5.2. Photos Space

Navigate to the Photo Space using the **Left** ◀ and **Right** ▶ buttons. Then use the **Up** ▲ and **Down** ▼ buttons to browse within the Photo Space (Fig. 50).

The Photo Space will display all of the supported video files that are accessible to the LaCinema HD Connect. Only files recognized as photo files will be displayed. Music and video files will not be displayed.

- **All Photos:** Displays all available photos, sorted alphabetically by name
- **By Date:** Displays photos according to when the picture was taken
- **By Folder:** Displays photos according to the volume's folder structure
- **Most Recent:** Displays the most recently played pictures only
- **USB1:** Displays photo files located on an external USB hard drive connected to the front or rear USB port (for details, refer to section 4. *Setting Up: Connecting USB Hard Drive*)

To load a picture, select the file you wish to display and press the **OK** button.

---

**NOTE:** It is possible to play music while watching a photo slideshow. To do so, first start the music via the **Music Space**. Then press the **Home** button, navigate to the **Photo Space**, then the photos you wish to play, and press the **OK** button.

---

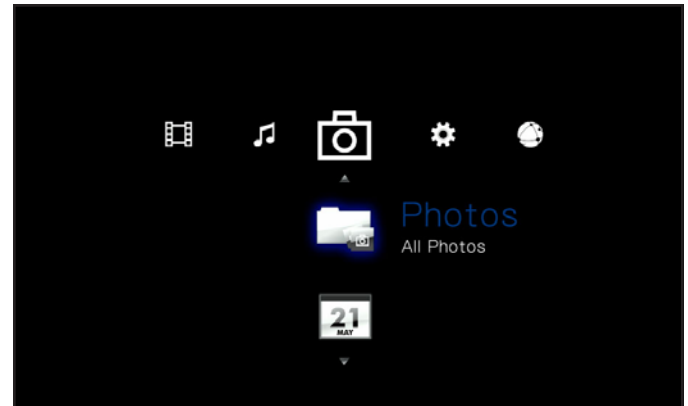

Fig. 50

### 5.2.1. Photo Space Options

While a photo is being displayed, you can adjust several playback parameters. Press the **Setup**  button to display or exit the on-screen menu, and use the **Left**  and **Right**  buttons to navigate to a setting and **OK** to adjust (see [Fig. 51](#) for reference). Once you've selected the option you want, click the **OK** button.

1. **Scroll**: If you have zoomed into a video, select this icon to scroll around the video. Use the direction buttons on your remote control.
2. **Rotate right**: Rotate the photo 90 degrees clockwise.
3. **Rotate left**: Rotate the photo 90 degrees counter-clockwise.
4. **Zoom in**: This feature allows you to zoom into a video. Once the feature has been selected, use the **Up** button to zoom in ([Fig. 52](#)).
5. **Zoom out**: To zoom out, select this icon and press the **Up** button.
6. **Change play mode**: Choose from:
  - a. Normal
  - b. Random ([Fig. 53](#))
  - c. Repeat one: The currently playing file will repeat continuously
  - d. Repeat all: All files in the current folder will play in succession repeatedly.
7. **Display info**: **Display info**: Click this button to display information about the currently playing file.

---

**NOTE:** You can pause the slideshow while adjusting settings.

---



---

**NOTE:** If you stop a slideshow, the settings for a given photo and for the slideshow will revert to the default when you replay.

---

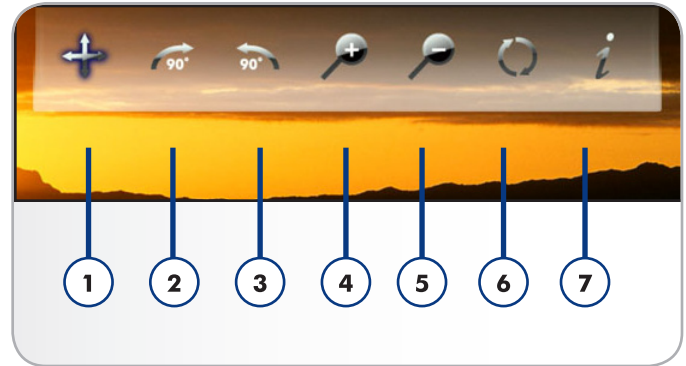

Fig. 51

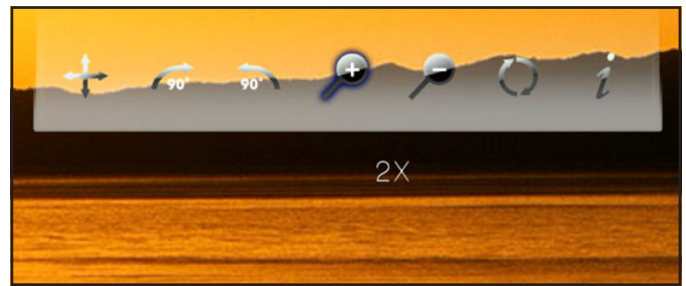

Fig. 52



Fig. 53

### 5.3. Music Space

Navigate to the Music Space using the **Left** ◀ and **Right** ▶ buttons. Then use the **Up** ▲ and **Down** ▼ buttons to browse within the Music Space (Fig. 54).

The Music Space will display all of the supported video files that are accessible to the LaCinema HD Connect. Only files recognized as audio files will be displayed. Photo and video files will not be displayed.

- **All Music:** Displays all available music files, sorted alphabetically by name
- **By artist:** Displays music files according to artist
- **By genre:** Displays music files according to genre
- **By album:** Displays music files according to album
- **By folders:** Displays music files according to the volume's folder structure
- **Most recent:** Displays the most recently added music files only
- **Playlist:** Displays playlists (M3U, PLS, and WPL files)
- **USB1:** Displays music files located on an external USB hard drive connected to the front or rear USB port (for details, refer to section 4. [Setting Up: Connecting USB Hard Drive](#))

[continued on the next page >>](#)

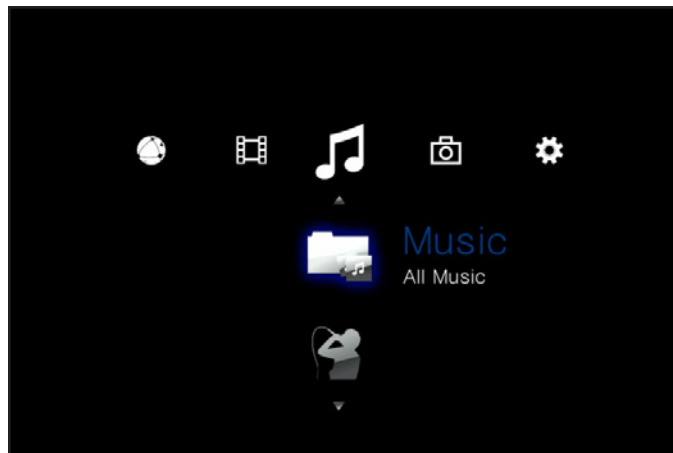

Fig. 54

■ **Now playing:** If a music file is playing, this icon will be present (Fig. 55). Clicking the **OK** button will take you to the Now Playing window. Click the **■** button to stop music playback.

To load a music file, select the file you wish to display and press the **OK** button.

---

**NOTE:** It is possible to watch a photo slideshow while listening to music. To do so, first start the music. Then press the **Home** button, navigate to the **Photos Space**, then the album you wish to display, and press the **OK** button (Fig. 56).

---

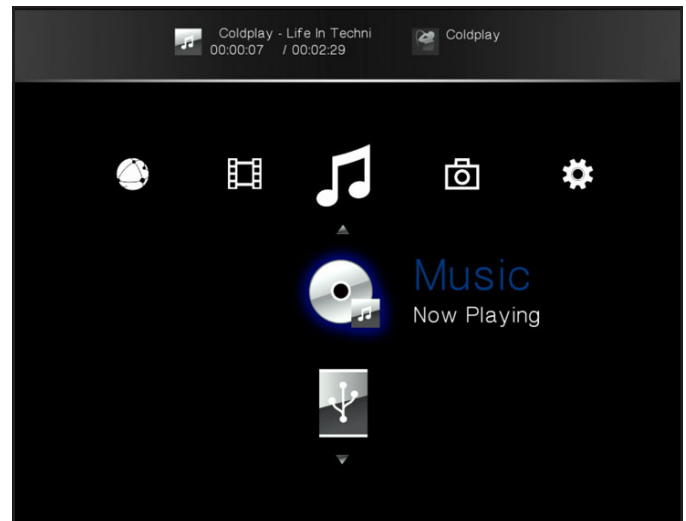



Fig. 55



Fig. 56

### 5.3.1. Music Space Options

During playback, you can adjust several parameters (Fig. 57). Press the **Setup**  button to display or exit the on-screen menu and configure the following settings. Once you've selected the option you want, click the **OK** button.

1. **Normal** : The currently playing file will repeat continuously (Fig. 58).
2. **Repeat one**: The currently playing file will repeat continuously (Fig. 59).
3. **Repeat all**: All files in the current folder will play in succession repeatedly (Fig. 60).

continued on the next page >>

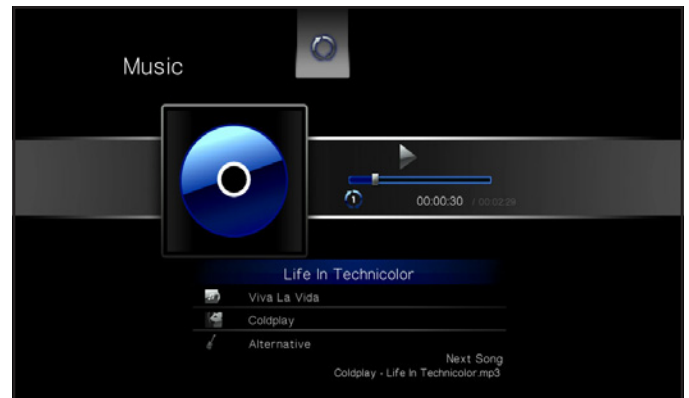

Fig. 57

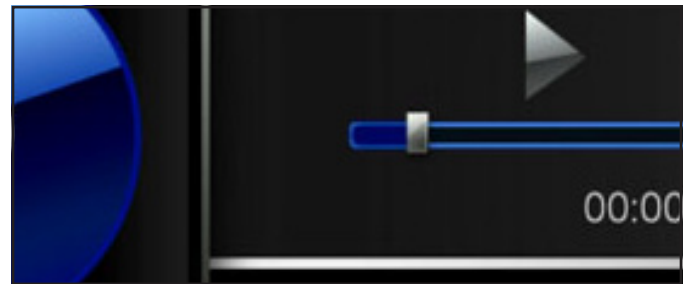

Fig. 58

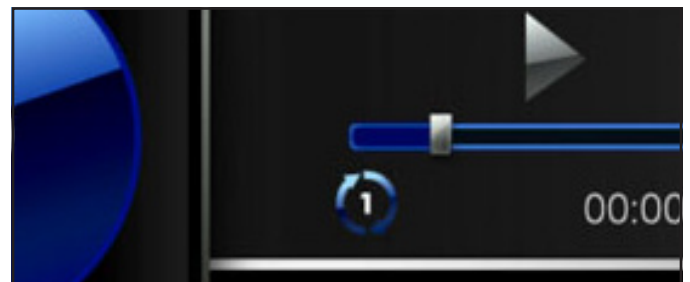

Fig. 59

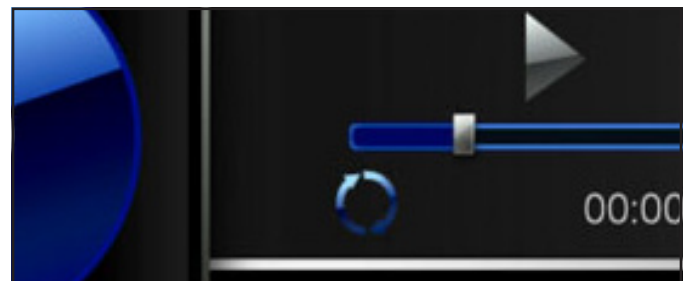

Fig. 60



- 
4. **Random:** Files in the current folder or playlist will play in random order (*Fig. 61*).
  5. **Random repeat all:** Files in the current folder or playlist will play in random order and in succession repeatedly (*Fig. 62*).
- 



Fig. 61



Fig. 62

## 5.4. Network Space

Navigate to the Network Space using the **Left** ◀ and **Right** ▶ buttons. Then use the **Up** ▲ and **Down** ▼ buttons to browse within the Network Space (Fig. 63).

From this menu, you can access files located on media servers and computer shared folders located on your home network.

### 5.4.1. Media Servers

Files located on networked UPnP/DLNA devices will appear in this section (Fig. 63). For more information on playing files from networked media servers, see 6. *Playing Files From a Networked Media Server*.

To play files, use the remote control to select the files and then press the **OK** button.

### 5.4.2. Shared folders

If you have configured certain folders on your PC or Mac to be shared on the network (see section 6.2. *From Windows or Mac Computers*), files located in these locations will be shown in **Shared folders** (Fig. 64).

To play files, use the remote control to select the files and then press the **OK** button.

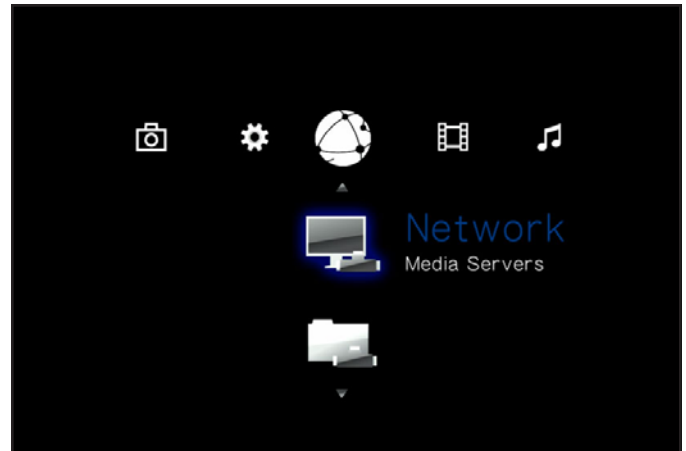

Fig. 63

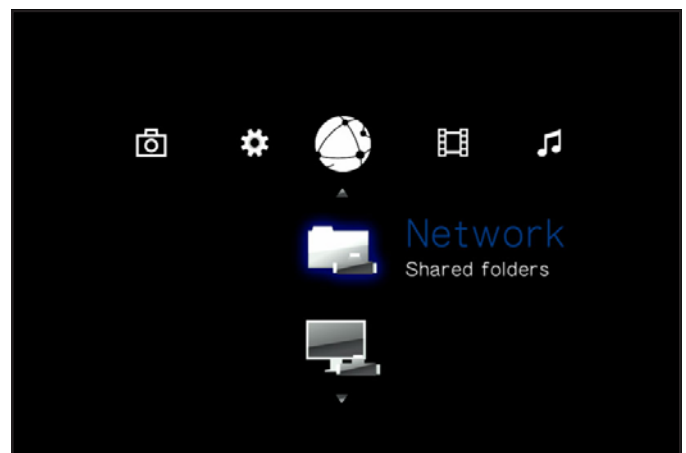

Fig. 64

## 6. Playing Files From a Networked Media Server

You can stream content to your LaCinema HD Connect via the network connection from a networked UPnP or DLNA server located on a host computer (Mac or PC) or a network-attached hard disk (NAS). In addition, the LaCinema HD Connect can read files from any UPnP device connected your Ethernet or wireless network. Once connected, files located on these sources will appear in the LaCinema HD Connect interface. For details, see below.

---

**TECHNICAL NOTE:** The WiFi connection may not be sufficient to stream HD movies. You will notice movie lagging or dropped images. Photo slideshow could also show some delay on display, but streaming music should not be a problem.

---

---

**TECHNICAL NOTE:** If you are having trouble streaming video, your router may be the limiting factor if it only supports 802.11g or lesser protocols. For best results streaming HD content, use a router that supports 802.11n.

---

### 6.1. Network-Attached Storage (NAS)

If you have a NAS running a media server, it is possible to stream this content to the LaCinema HD Connect. In order to view your NAS content on LaCinema HD Connect, first make sure that both devices are connected to the network (Fig. 65). Once connected, files located on the NAS will appear in the various Spaces on the LaCinema HD Connect.

---

**TECHNICAL NOTE:** It is not possible to transfer files from a NAS to the external hard drive connected to the LaCinema HD Connect using the TV interface. In this case, transfer files first to your computer, then follow the steps in section 4. [Setting Up: Connecting USB Hard Drive](#).

---

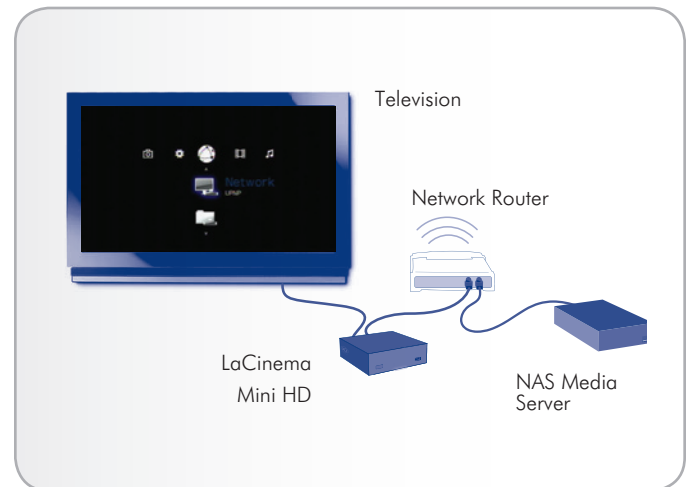

Fig. 65

## 6.2. From Windows or Mac Computers

You can install software on your computer which will enable it to act as a UPnP media server and stream files to the LaCinema HD Connect via your Ethernet or wireless network. Once the software has been installed and configured, files located on the host computer will appear in the various Spaces on the LaCinema HD Connect (see Fig. 66). Choose from two different software:

Software	Compatibility
6.2.1. Packet Video TwonkyVision	PC/MAC
6.2.2. Windows Media Player (WMP)	PC only

### 6.2.1. Packet Video TwonkyVision

1. From the Utilities CD-ROM, install the Packet Video TwonkyVision software.
2. Once installed, launch the server from the Start Menu (Windows users) or the Applications folder (Mac users).
3. In the configuration page that opens in your web browser, click on the **Sharing** link and then select the folders on your computer that contain the multimedia content you wish to access from the LaCinema HD Connect (Fig. 67). Make sure to click the **Save Changes** button when you finish.
4. It may be necessary to restart the server. To do so, select the **First Steps** link and click **Restart server**.
5. You will now be able to access your computer's multimedia content using the LaCinema HD Connect remote control. Files will appear in the various Spaces on the LaCinema HD Connect.

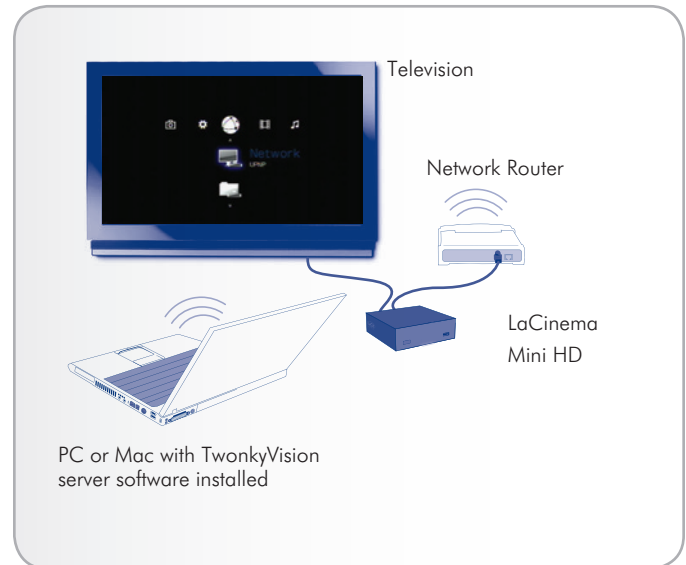

Fig. 66

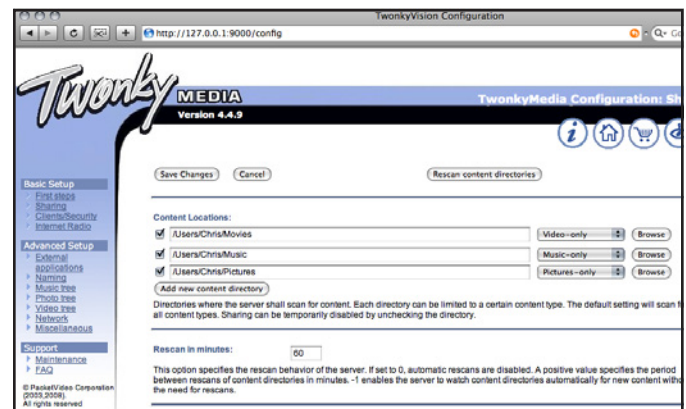

Fig. 67

### 6.2.2. Windows Media Player (WMP)

**IMPORTANT INFO:** This software is compatible with Windows only.

Install Windows Media Player (WMP) 11 to allow you to stream content to the LaCinema HD Connect via your Ethernet or wireless network. Follow these steps to configure the connection:

1. Make sure that the software is installed on your computer.

**TECHNICAL NOTE:** WMP is preinstalled on Vista and Windows 7, but XP users may have to download and install the software.

2. Make sure that your computer, the LaCinema HD Connect, and any UPnP devices are properly connected to your network (Fig. 68).
3. In WMP, turn on Media Sharing by clicking on **Library > Media Sharing...** (Fig. 69).
4. In the **Media Sharing** dialogue box, select **Share My Media to...** You must then tell WMP to share content with the LaCinema HD Connect. Below the Share My Media check box, select the LaCinema HD Connect and click **Allow** (Fig. 70).
5. Multimedia content imported into WMP will now be accessible in the various Spaces on the LaCinema HD Connect.

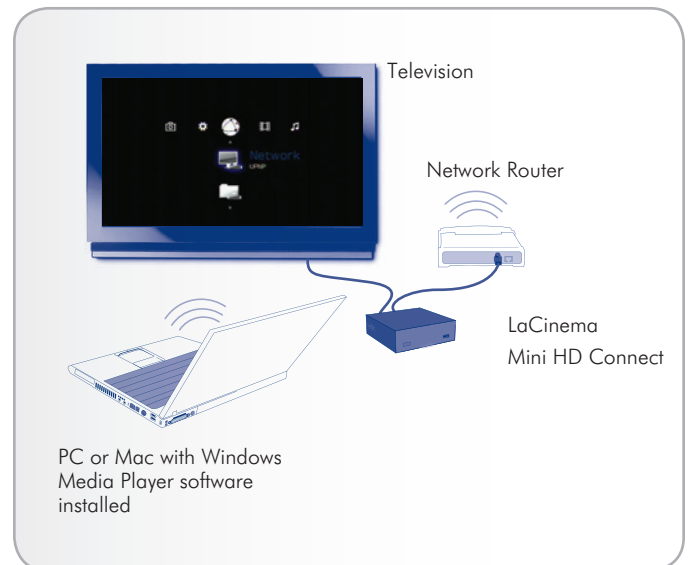

Fig. 68

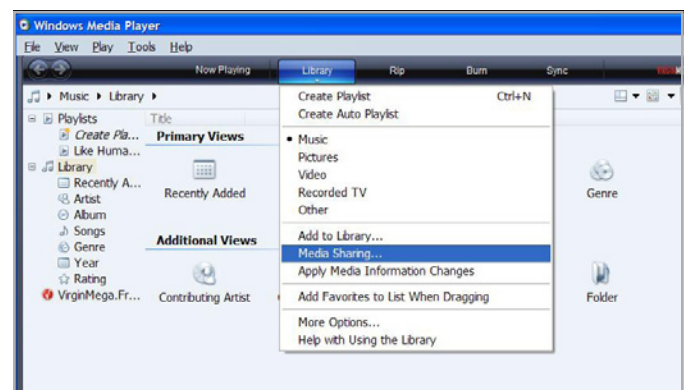

Fig. 69

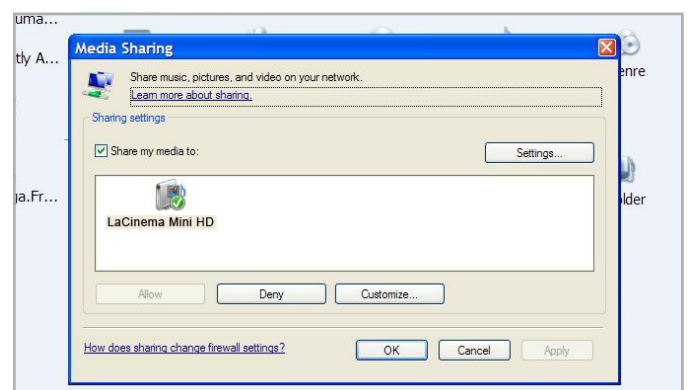

Fig. 70

### 6.2.3. Shared folders on your Computer

After you modify some settings in your operating system, you can make files located in certain folders on your computer available for playback on your LaCinema HD Connect in **Network > Shared Folders** (Fig. 71). Follow the steps below according to your operating system.

#### Windows XP

1. Log on to your computer as an administrator.
2. Right-click the folder that you want to share, and then click **Sharing and Security** (Fig. 72).
3. If you see a message that reads, **As a security measure, Windows has disabled remote access to this computer**, click the **Network Setup Wizard** link (Fig. 73). Then follow the instructions in **How to set up your computer for home networking**. On the File and printer sharing page of the Network Setup Wizard, be sure to select **Turn on file and printer sharing**. If you do not see this message, skip this step and go to step 4.
4. In the **Properties** dialog box, select the **Share this folder on the network** check box (Fig. 74).
5. Click **OK**. Windows Explorer will show a hand holding the folder icon, indicating that the folder is now shared.

The files contained in the folders you select will now be available to the LaCinema HD Connect in **Network > Shared Folders**.

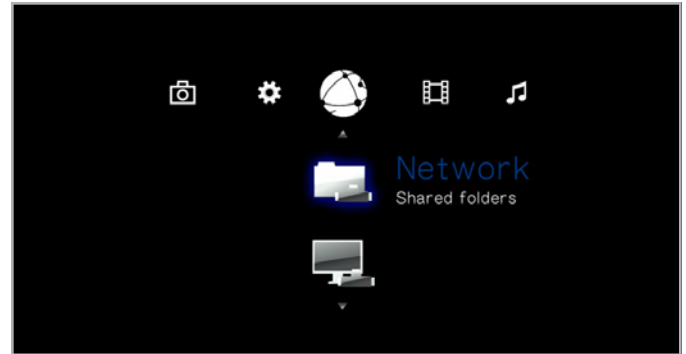

Fig. 71

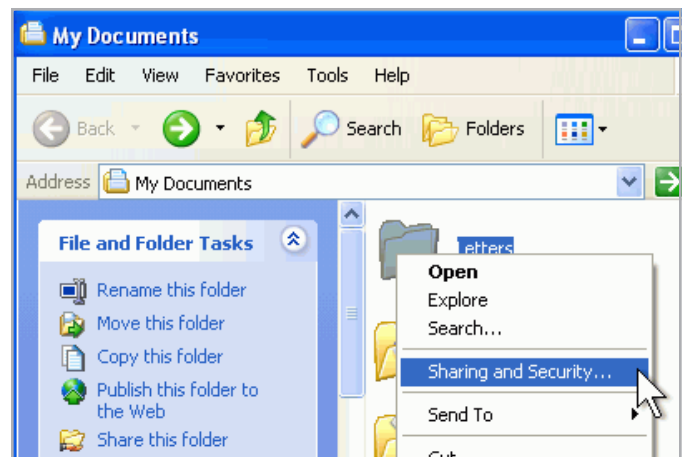

Fig. 72

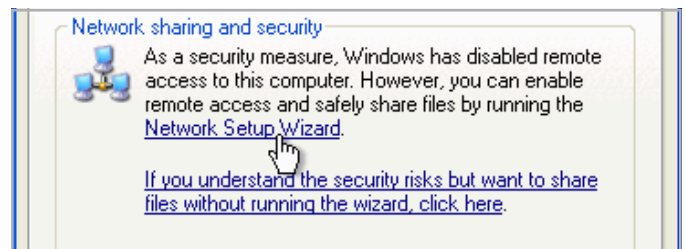

Fig. 73

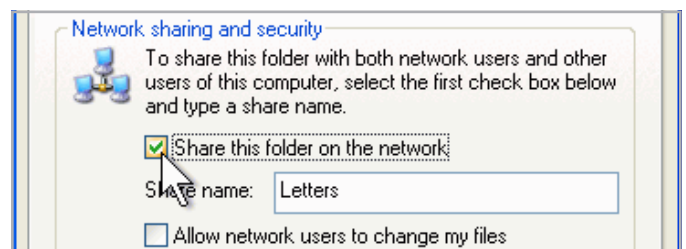

Fig. 74

### Windows Vista

1. Locate the folder with the files you want to share.
2. Right-click the folder that you want to share, and then click **Share** (Fig. 75).
3. In the File Sharing dialog box, click the arrow to the right of the text box and click **Everyone** to share the files with any device on your network (Fig. 76, 1), and then click **Add** (Fig. 76, 2).
4. Under Permission Level, click the arrow next to Everyone and select **A Contributor** (Fig. 76, 3).
5. When you are finished, click **Share** (Fig. 76, 4). If you are prompted for an administrator password or confirmation, type the password or provide confirmation.

The files contained in the folders you select will now be available to the LaCinema HD Connect in **Network > Shared Folders**.

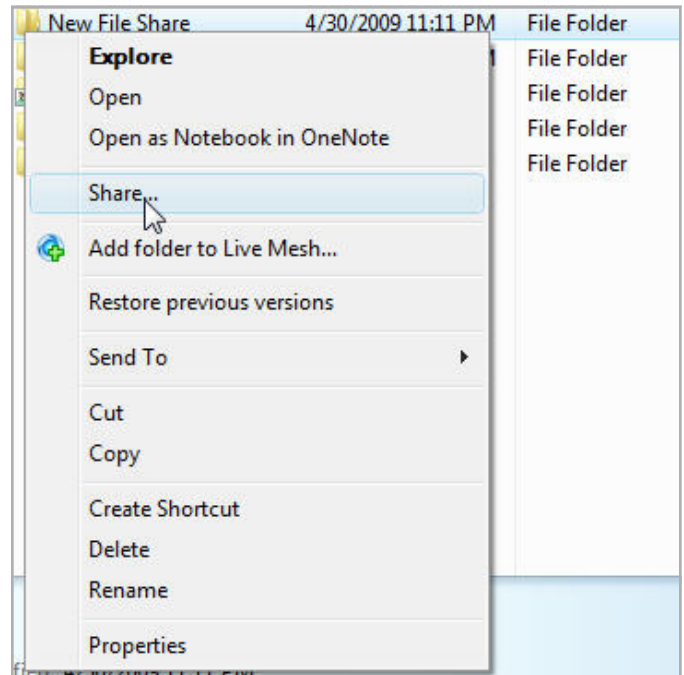

Fig. 75

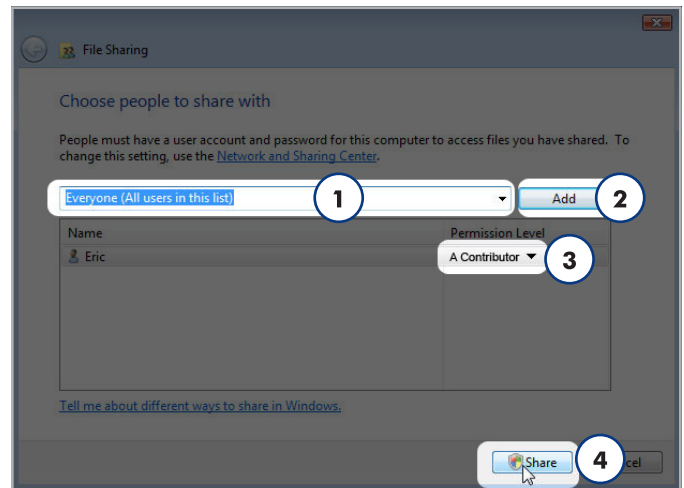

Fig. 76

### Mac OS X 10.5.x & 10.6.x

1. Open your System Preferences and select **Sharing**.
2. Click **File Sharing** in the left-hand column and check the box (Fig. 77, 1).
3. Click the **+** sign under the column **Shared Folders** (Fig. 77, 2), and add the folders you would like to share with the LaCinema HD Connect.
4. Select the first folder listed under Shared Folders. In the right-hand column, click on the permissions type for **Everyone** and select **Read & Write** (Fig. 77, 3).
5. Still in File Sharing preferences, click the **Options** button in the lower right-hand corner (Fig. 77, 4). In the window that opens, select **Share files and folders using SMB**.

The files contained in the folders you select will now be available to the LaCinema HD Connect in **Network > Shared Folders**.

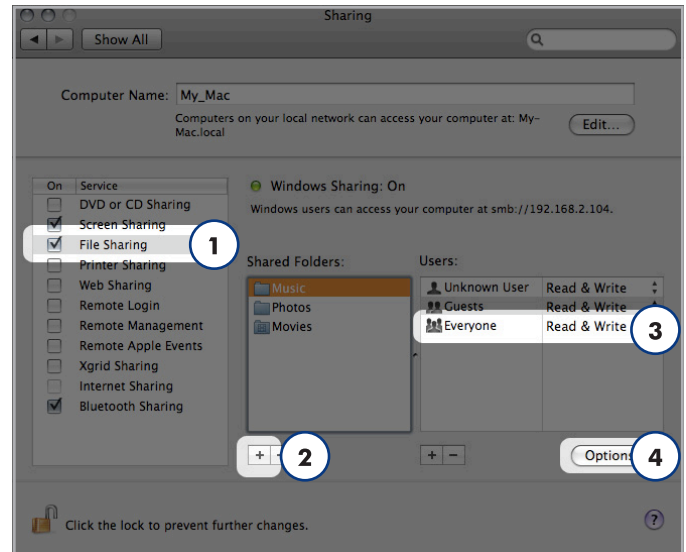

Fig. 77

### Mac OS X 10.4.x

1. Open your System Preferences and select **Sharing** in the **Internet & Network** section.
2. Click the **Services** tab, then select the check box next to **Personal File Sharing**.

The files contained in the folders you select will now be available to the LaCinema HD Connect in **Network > Shared Folders**.

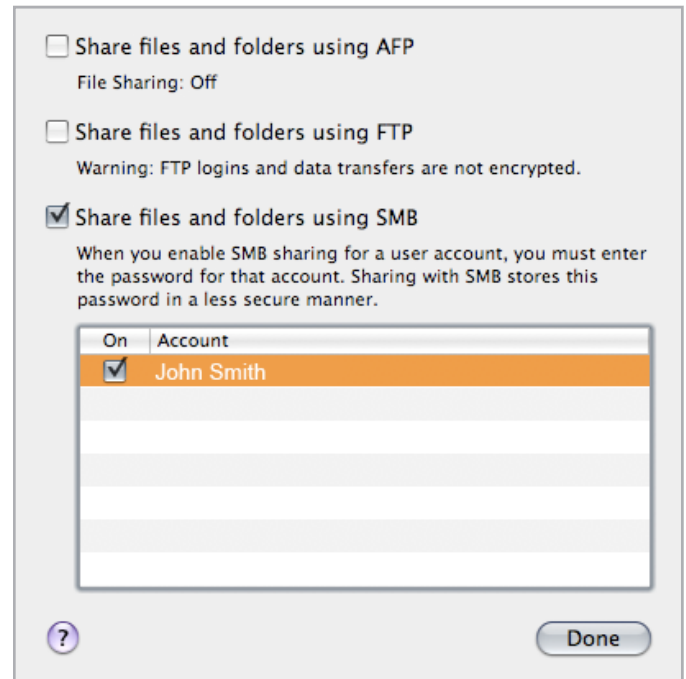

Fig. 78



## 7. Sharing Files Throughout Your Home Network

Thanks to its support for the network protocols, your LaCinema HD Connect can share files located on an external USB connected to one of its USB ports to computers and digital media players on your network.

To manage files located on the external hard drive connected to the LaCinema HD Connect from a networked PC or Mac, see section [7.1. Manage Files from a Networked Computer](#).

---

### 7.1. Manage Files from a Networked Computer

It is convenient to use the network connection to transfer, move, or delete files located on the external hard drive connected to the LaCinema HD Connect once it has been connected to the TV. Follow these steps to manage files using your networked computer:

[7.1.1. STEP 1: Verify Physical Connection](#)

[7.1.2. STEP 2: LaCie Network Assistant: Install](#)

[7.1.3. STEP 3: LaCie Network Assistant: Manage Files](#)

---

### 7.1.1. STEP 1: Verify Physical Connection

1. First, make sure the LaCinema HD Connect has been connected to the TV and network as described in section 3. [Setting Up: Connecting to TV & Network](#).
2. Next, make sure the external hard drive has been connected as described in section 4. [Setting Up: Connecting USB Hard Drive](#).

### 7.1.2. STEP 2: LaCie Network Assistant: Install

LaCie Network Assistant software detects all LaCie network attached storage devices (and external hard drives connected to them) on your network and gives you easy ways to connect to or configure them.

Once installed and running, LaCie Network Assistant (LNA) will appear in your task bar (Windows users) or in the menu bar (Mac users) and automatically search for storage devices on your network. When a new device is found, the icon will blink.

When LNA finds the LaCinema HD Connect on the network, you can access the external hard drive to manage files, and you can use LNA to configure the LaCinema HD Connect's network settings.

---

**TECHNICAL NOTE:** As an alternative to using the LaCie Network Assistant to access the drive, you can use its IP address to open a network (SMB) connection. See section 7.1.4. [Alternative Network Connection Methods](#) for more details. The IP address can be found by using the remote control to navigate to [Settings > Network > Network Setup](#).

---

### Install LaCie Network Assistant:

1. Insert the CD-ROM into your computer's CD-ROM drive.
2. Windows users, the CD should appear in My Computer. Mac users, the CD should appear on the desktop. Double-click the CD icon, then double-click "LaCie Network Assistant Setup" (Fig. 79).
3. Follow the Wizard to complete installation.

Now move on to the next step, 7.1.3. [STEP 3: LaCie Network Assistant: Manage Files](#).

---

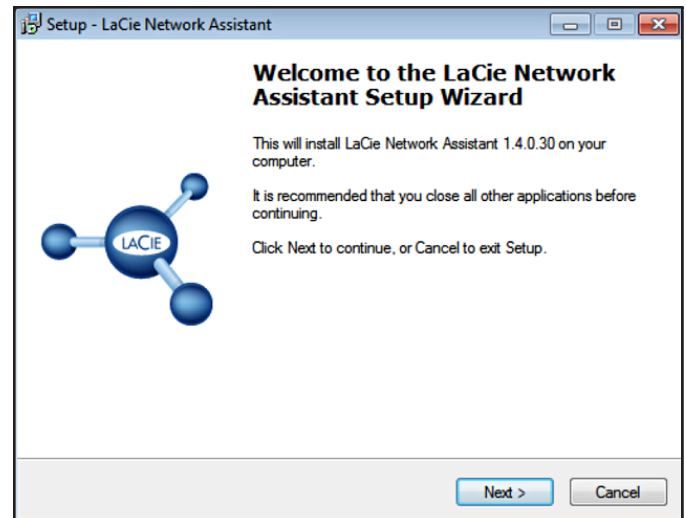

Fig. 79

### 7.1.3. STEP 3: LaCie Network Assistant: Manage Files

#### Windows Users:

- Select LaCie Network Assistant in Start/Programs. A Network Assistant icon will appear in the system tray (Fig. 80) and Network Assistant will automatically detect your LaCinema HD Connect.
- From the system tray, click the LaCie Network Assistant icon then **MiniHD > LaCie** (Fig. 82) or **Connect Manually**. The volume will open in an explorer window.
- Drag files or folders onto this volume, reorganize them, or delete them.

#### Mac Users:

- Select LaCie Network Assistant in your Applications folder. A Network Assistant icon will appear in the menu bar (Fig. 81) and Network Assistant will automatically detect your LaCinema HD Connect.
- From the menu bar, click the LaCie Network Assistant icon then **MiniHD > LaCie** or **Connect Manually**. The volume will open in a Finder window.
- Drag files or folders onto this volume, reorganize them, or delete them.

[continued on the next page >>](#)

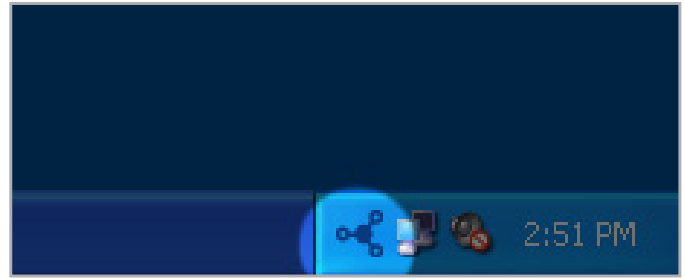

Fig. 80



Fig. 81

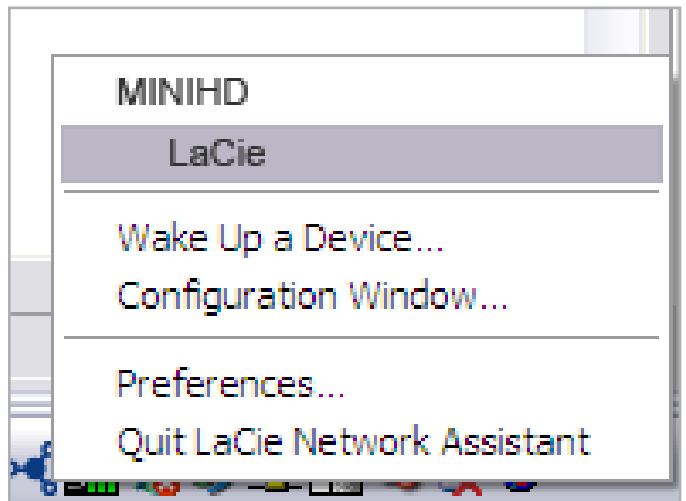

Fig. 82

---

---

**IMPORTANT INFO:** Make sure that IPConf support is activated in the LaCie Network Assistant preferences (Fig. 83, PC users, and Fig. 84, Mac users).

---

---

---

---

**IMPORTANT INFO:** If you want to delete files from the external hard drive connected to the LaCinema HD Connect, you must empty the Trash or Recycle Bin after moving the files there. Otherwise, the files will still have a reference and occupy hard drive space.

---

---

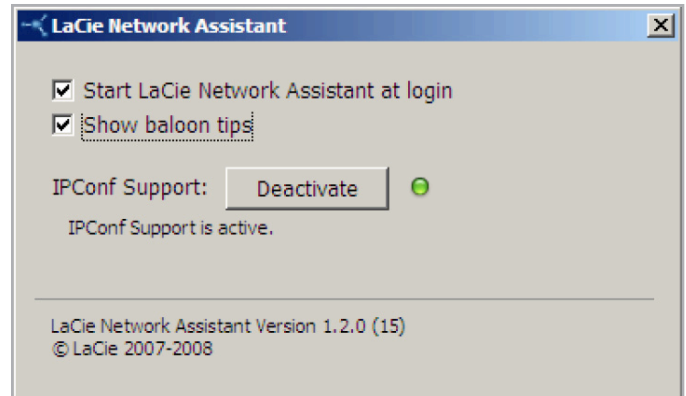

Fig. 83

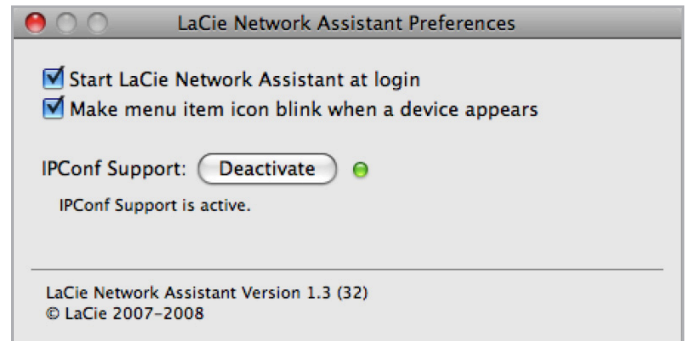

Fig. 84

### 7.1.4. Alternative Network Connection Methods

If your LaCinema HD Connect is connected to your home network, it is possible to access its volume without using the LaCie Network Assistant.

#### Windows Users

To access the volume in Windows, look in My Network Places, and select Microsoft Windows Workgroup. By default, the volume will be named **MiniHD** \* (Fig. 85).

Alternatively, you can access the volume by typing the following in a Windows explorer address field:

`smb://MiniHD` \* or `smb://[IP address]` \*\*

#### Mac Users

From the Finder, select **Go** and then **Connect to Server...** In the window that opens, type (Fig. 86):

`smb://MiniHD` \* or `smb://[IP address]` \*\*

[If your drive is connected to the TV, you can find the IP address using the remote control by navigating to Settings > Network.]

Click **Connect**.

Alternatively, you can find the drive listed in the Network folder.

\* If you changed the machine name in the Settings Space, type this name instead.

\*\* The IP address can be found by using the remote control to navigate to **Settings > Network > Network setup**.

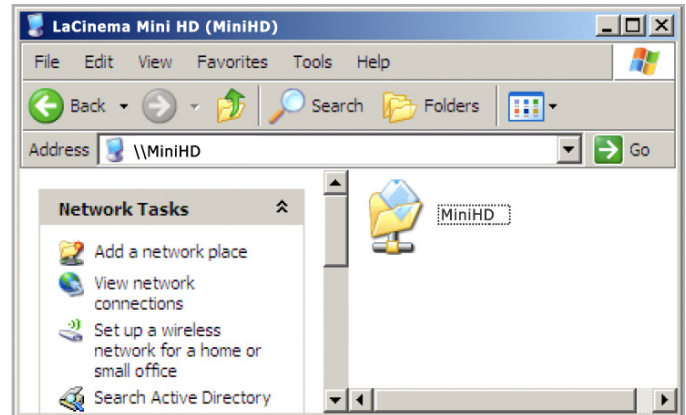

Fig. 85

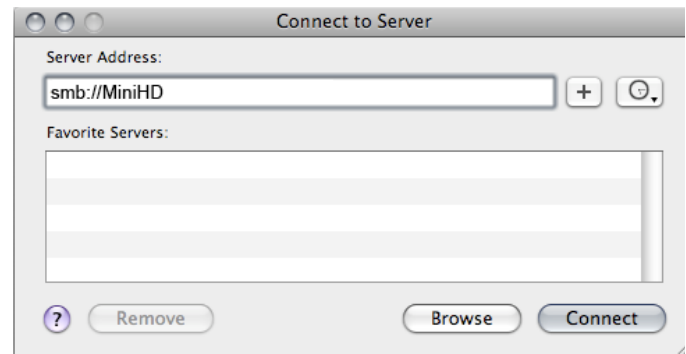

Fig. 86

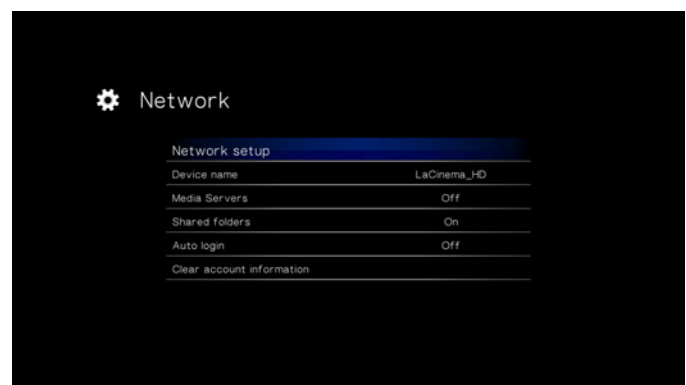

Fig. 87

## 8. Formatting External USB Hard Drives

Please read the following information on file system formats for Windows and Mac operating systems to determine if you need to reformat your external hard drive to work with LaCinema HD Connect.

If you would like to reformat the drive, follow the steps below for your operating system. The following chart will help you decide which file format is most appropriate for your use. Once you've chosen a file format, see sections [8.1. Formatting: Windows Users](#) and [8.2. Formatting: Mac Users](#) for instructions on reformatting.

---

### Windows File System Formats

#### NTFS

NTFS is the ideal format if you will be using the drive only with Windows machines (performance will generally be greater when compared to FAT 32 without the file size restriction).

#### MS-DOS (FAT32)

MS-DOS (FAT32) is a good file format if you will be using your drive with both Windows and Macs. MS-DOS (FAT32) has a maximum single file size restriction of 4GB. This means you cannot transfer files larger than 4GB to the drive.

---

### Mac File System Formats

#### HFS+ (non-journaled)

HFS+ is the ideal file format if you will be using the drive on Macs only; performance is generally superior to that offered by FAT 32 without the file size restriction.

#### MS-DOS (FAT32)

MS-DOS (FAT32) is a good file format if you will be using your drive with both Windows and Macs. MS-DOS (FAT32) has a maximum single file size restriction of 4GB. This means you cannot transfer files larger than 4GB to the drive.

---

## 8.1. Formatting: Windows Users

The process of formatting a drive on a computer running Windows XP, Windows Vista, or Windows 7 consists of two steps: (1) installing a signature on the drive, and (2) formatting the drive. These steps will erase anything that is on the disk.

**CAUTION:** Following these steps will erase everything from the hard drive. If you have information that you want to protect or continue to use, back up this information before performing these steps.

1. Connect the drive to the computer via the interface port.
2. Right-click **My Computer** and select **Manage**.
3. From the “Computer Management” window, select **Disk Management** (located below the **Storage** group). See *Fig. 88*.
4. If the “Initialize and Convert Disk Wizard” window appears, click **Cancel**.
5. Windows will list the Hard Disks that are installed on the system. Locate the drive that is represented by the  icon. Right-click the icon and select **Initialize**.
6. In the box to the right that says **Unallocated**, right-click and select **New Partition...**
7. On the first page of the “New Partition Wizard,” click **Next**. See *Fig. 89*.

continued on next page

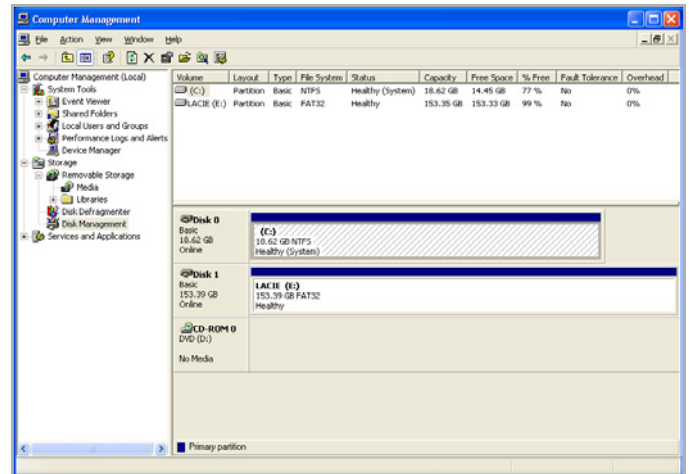

Fig. 88

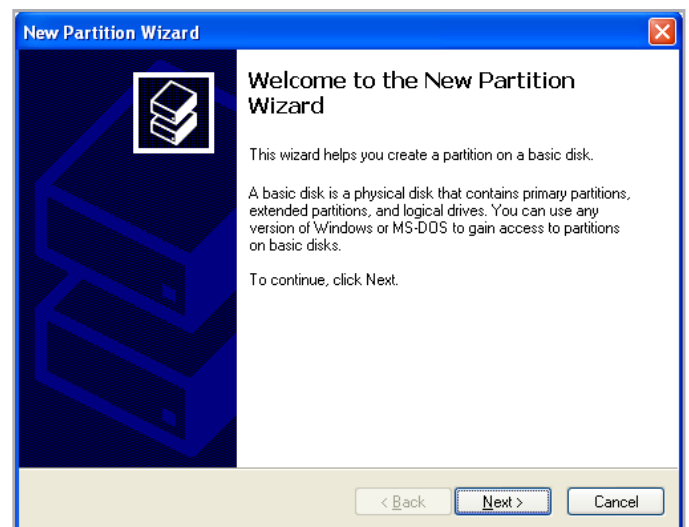

Fig. 89

8. Click [Next](#).
9. Click [Next](#).
10. Click [Next](#).
11. Click [Next](#).
12. On the Format Partition window, select [Quick Format](#) (Fig. 90). Click [Next](#).
13. Click [Finish](#) to begin the formatting process.
14. Windows Disk Management will format and partition the disk according to your settings (Fig. 91), and your drive will appear in [My Computer](#), ready to use.

---

**IMPORTANT INFO:** If you choose to format the hard drive in MS-DOS (FAT32), which is compatible with almost all computers, keep in mind that you will not be able to transfer files larger than 4GB to the drive.

---

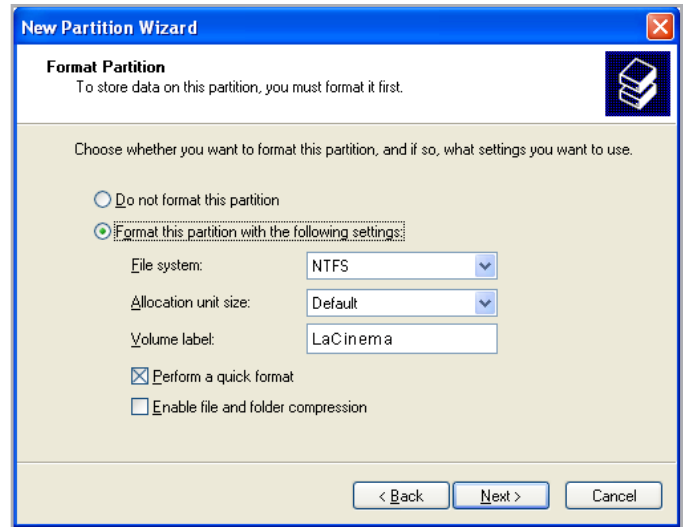

Fig. 90

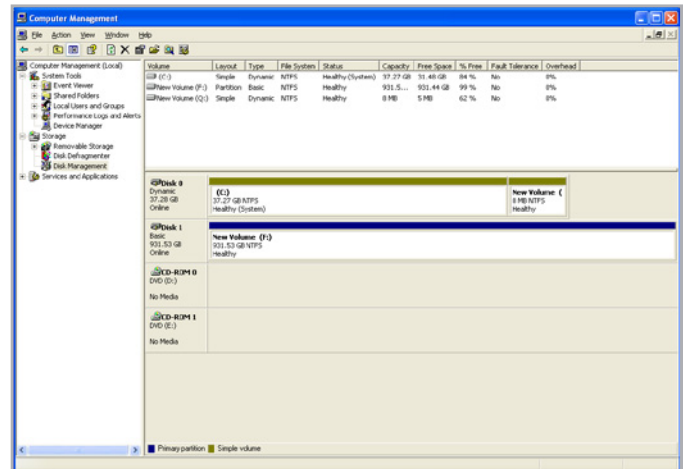

Fig. 91



## 8.2. Formatting: Mac Users

**CAUTION:** Following these steps will erase everything from the hard drive. If you have information that you want to protect or continue to use, back up this information before performing these steps.

1. Connect the drive to the computer and turn on the drive.
2. Select **Utilities** from the **Go** menu in the Finder menu bar.
3. In the Utilities folder, double-click **Disk Utility**.
4. The Disk Utility window will open. Select the volume labeled **LaCie Hard Disk** from the list of available hard disks on the left side of the window.
5. Select the **Partition** tab.
6. From the **Volume Scheme:** menu, choose the number of partitions you want to divide the drive into (Mac OS X gives you the option of dividing the drive into at most 16 partitions). You can adjust the size of each partition using the slide bar between the partitions in the **Volume Scheme:** area (Fig. 92).
7. In the **Volume Information** section, enter a name for each volume (partition), and choose a file system (Mac OS Extended or MS-DOS) from the drop-down menu (Fig. 93).

**IMPORTANT INFO:** Do not choose Mac OS Extended (Journaled), as this file system is incompatible with the LaCinema HD Connect.

8. Once you have finalized the volume options, click **Partition**. Click **Partition** again when the alert message appears to continue.
9. Mac Disk Utility will format and partition the disk according to your settings, and your drive will be ready to use.

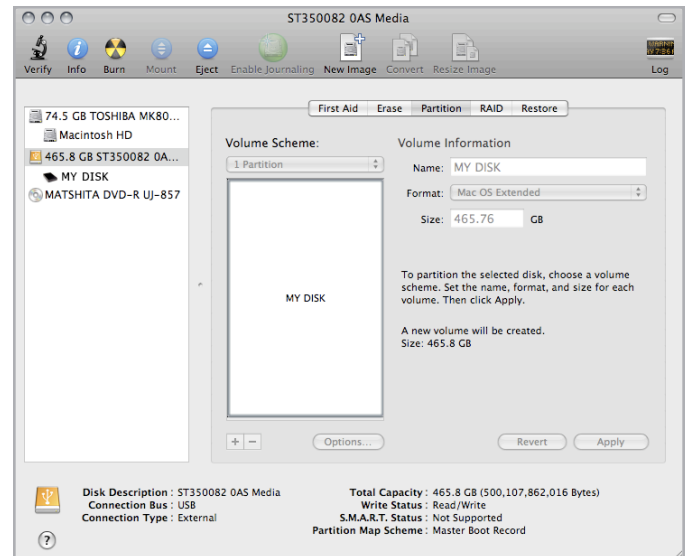

Fig. 92

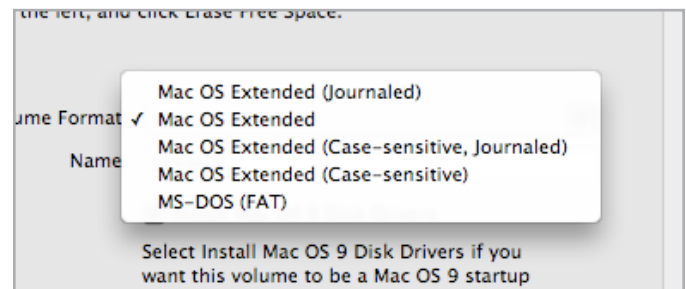







Fig. 93

## 9. Settings Menu

The LaCinema HD Connect **Setup Space** will help you to properly configure and customize your device. Access it at any time by clicking the **Setup**  button. When the setup menu is shown, the playback will be automatically paused.

Scroll through the Setup menu using the **Up**  and **Down**  buttons (Fig. 94).

To display the available options of a setup category, press the **Right**  or **OK** button. To confirm your choice, press the **OK** button. All changes are automatically saved.

To select another option, press the **Return**  button to go back to an previous menu. Press the **Setup**  button again to exit the setup menu from the screen.

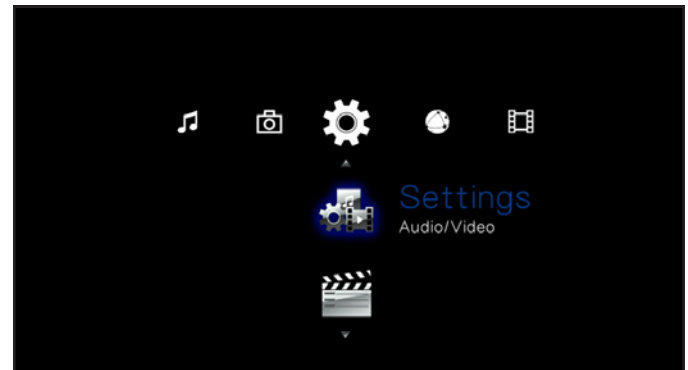

Fig. 94

### 9.1. Settings: Audio/Video

#### 9.1.1. Video Output

The LaCinema Mini HD Connect automatically detects which type of video output connection you have made (**HDMI** or **Composite**). If the HDMI cable is connected, the composite setting will not be selectable. Make sure to connect EITHER the HDMI or composite cable, but not both at the same time.

Select **Video Out**, then choose from the following options (Fig. 96):

- Composite
- HDMI

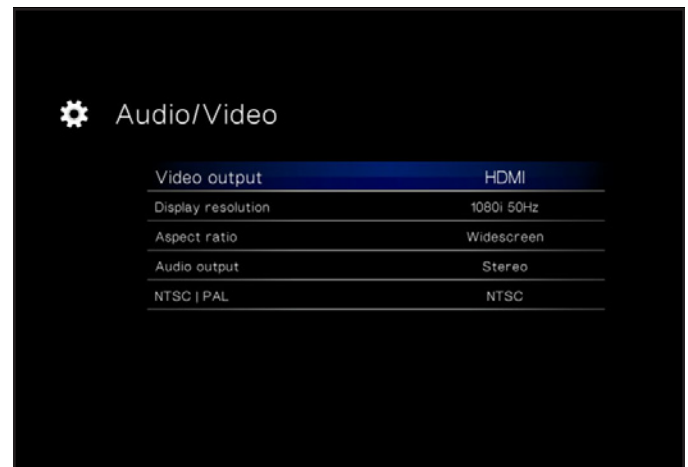

Fig. 95



Fig. 96

### 9.1.2. Display Resolution

Choose a display resolution to match your television (default is [Auto](#)).

### 9.1.3. Aspect Ratio

Depending on your television's setup, choose either ([Fig. 97](#)) (note that [Widescreen](#) is the default setting):

- Normal
- Widescreen

### 9.1.4. Audio Output

Choose either ([Fig. 98](#)) (note that [Stereo](#) is the default setting):

- Stereo
- Digital

---

**IMPORTANT INFO:** If you connected the S/PDIF cable, make sure to select the [Digital](#) option.

---

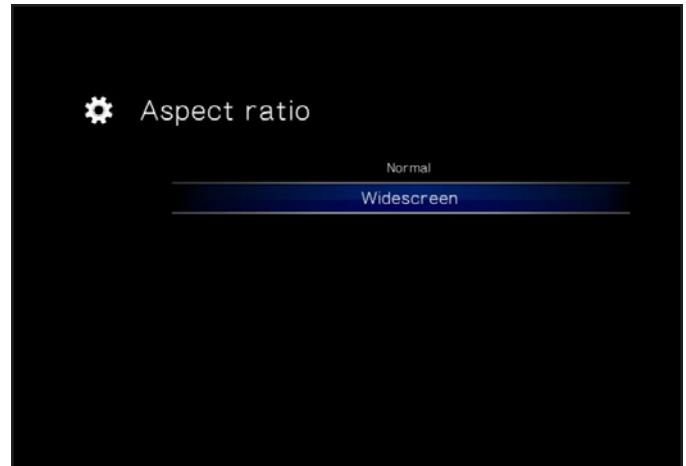

Fig. 97

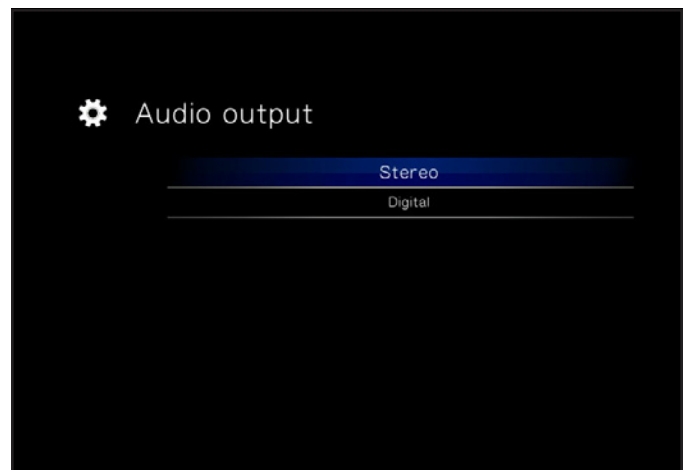



Fig. 98

### 9.1.5. NTSC/PAL

Depending on your television's configuration, choose either PAL or NTSC (Fig. 99) (note that PAL is the default setting). Alternatively, you can change this setting by pressing and holding the **Setup**  button until the standard changes.

- NTSC
- PAL

## 9.2. Settings: Video

### 9.2.1. Video Sequence

Choose from the following (Fig. 100):

- **Normal**
- **Repeat One:** The currently playing file will repeat continuously
- **Repeat All:** All files in the current folder will play in succession repeatedly



Fig. 99

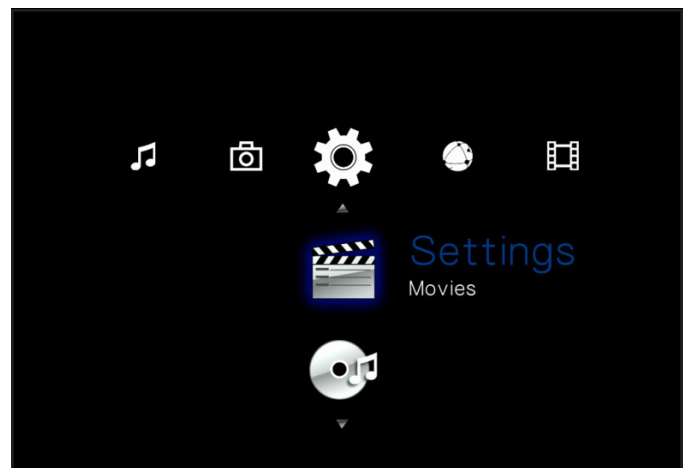

Fig. 100

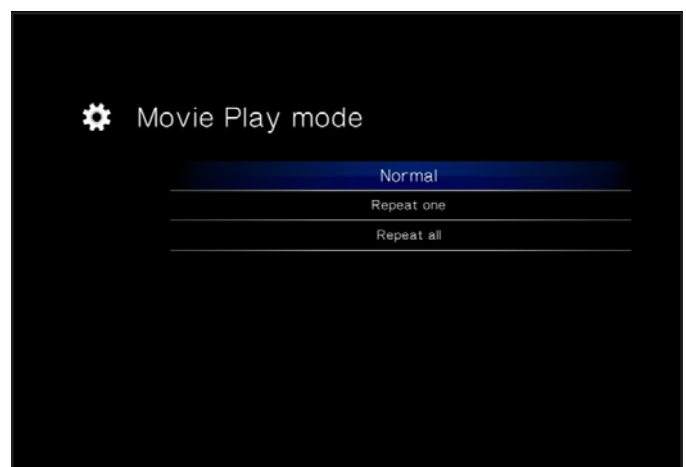

Fig. 101

### 9.2.2. Subtitle Font Size

Choose from a range of 24pt to 40pt ([Fig. 102](#)):

---

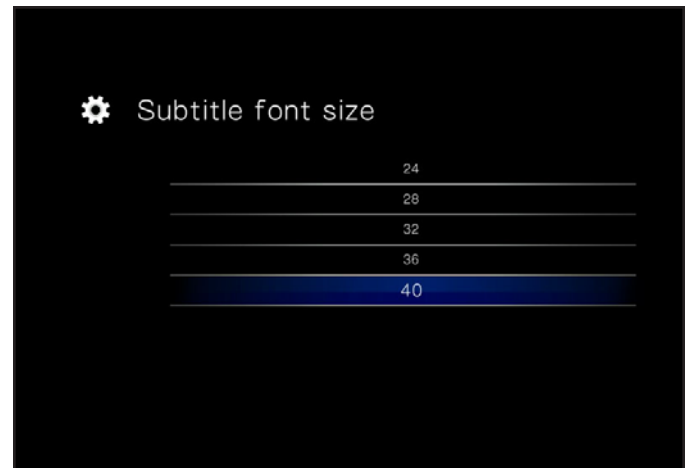

Fig. 102

---

## 9.3. Settings: Music

### 9.3.1. Music Sequence

Choose from the following (Fig. 103):

- **Repeat one:** The currently playing file will repeat continuously.
- **Repeat all:** All files in the current folder will play in succession repeatedly.
- **Random:** Files in the current folder or playlist will play in random order.

### 9.3.2. Audio Track Display

The parameter affects how audio tracks are displayed (Fig. 104).  
Choose from:

- File name
- Title

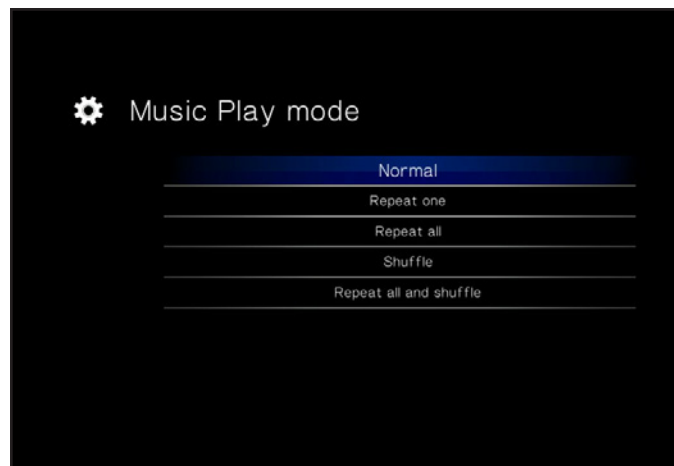

Fig. 103

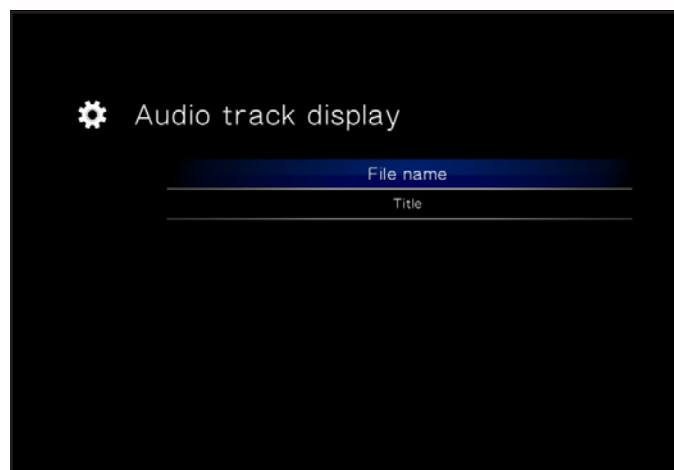

Fig. 104

## 9.4. Settings: Photo

### 9.4.1. Slideshow

This parameter allows you to change the way pictures are played back (default is **Normal**) (Fig. 106):

- Normal
- Shuffle
- Repeat All
- Repeat All and Shuffle

### 9.4.2. Picture Scaling

This parameter affects how the picture fits on screen (default is **Keep as Original**) (Fig. 107):

- Keep as Original
- Fit to Screen
- Display in Full Screen

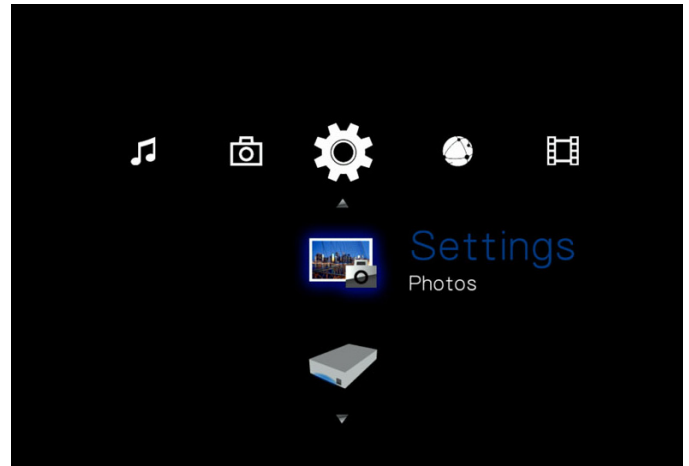

Fig. 105

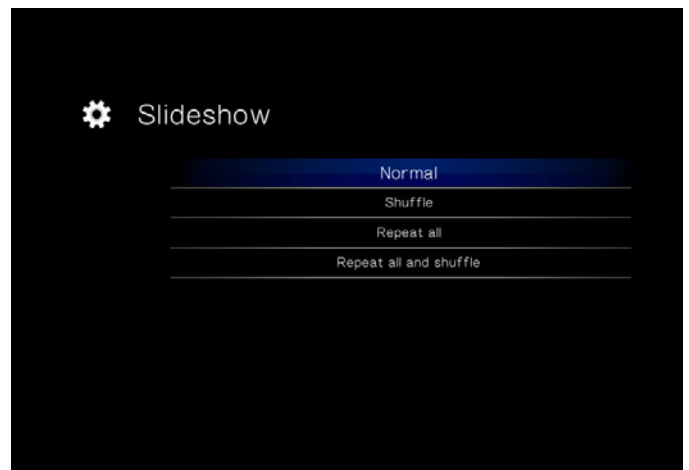

Fig. 106

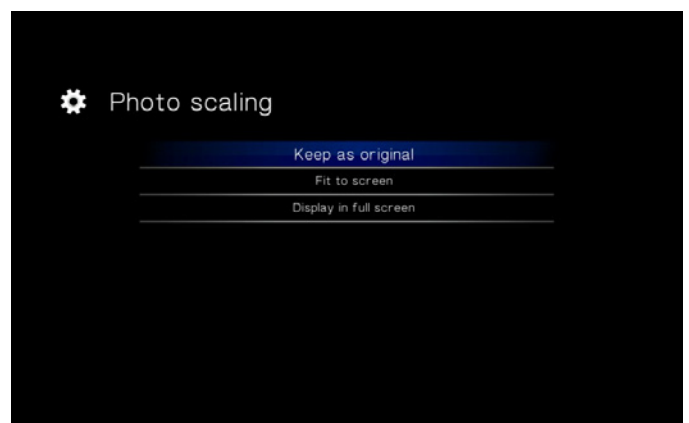

Fig. 107

### 9.4.3. Transition Effect

This parameter allows you to modify the transition effects between photos (default is **Normal**) (Fig. 108):

- Normal
- Fade
- Random

### 9.4.4. Interval Time

This settings allows you to set the amount of time a photo is displayed (default is **3 Seconds**) (Fig. 109):

- 3
- 5
- 10
- 20
- 30
- 1 Minute
- 5 Minutes

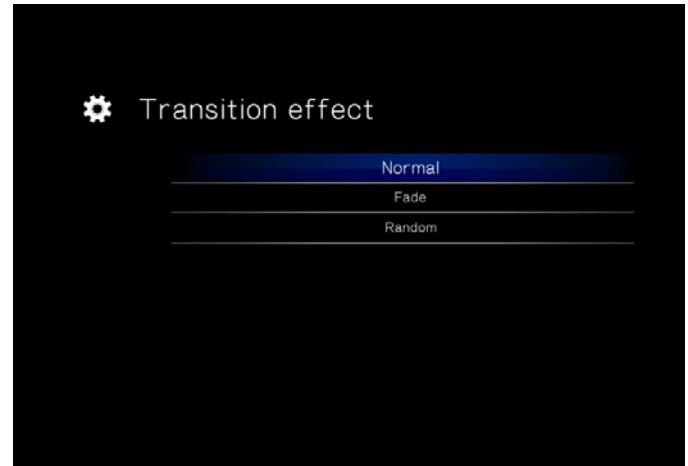

Fig. 108

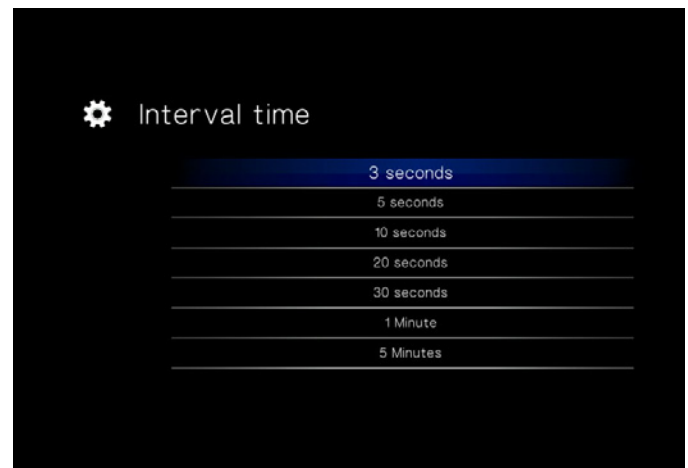

Fig. 109



## 9.5. Settings: System

### 9.5.1. Language

Choose your language.

---

### 9.5.2. Content Aggregation

This setting activates or deactivates the file database, which allows you to browse files within each media type according to certain parameters (file type, date, recent, etc.). Since this feature is turned off by default, if it is kept off, you will be able to browse files in the different media spaces alphabetically only (or, in the case of the Music Space, additionally according to artist, genre, and album) (Fig. 110).

---

### 9.5.3. Screensaver Delay

This setting controls how long a period of inactivity will last before the screensaver turns on (Fig. 111).

---

### 9.5.4. Browse Mode

This setting allows you to change how files are displayed in a list (default is **Thumbnail**) (Fig. 112):

- Thumbnail
  - List mode
- 



Fig. 110

---

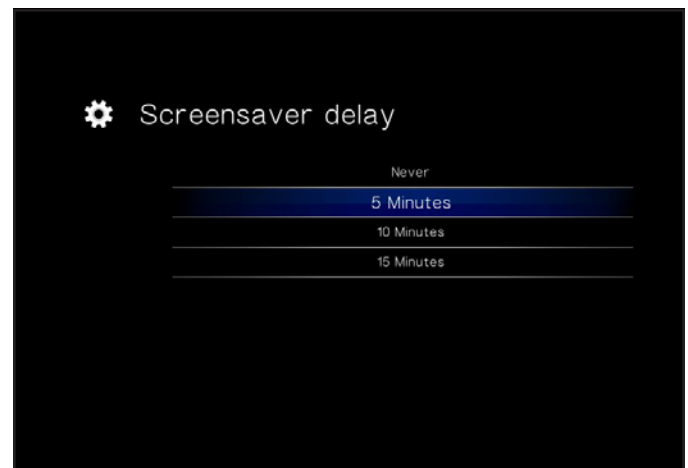

Fig. 111

---

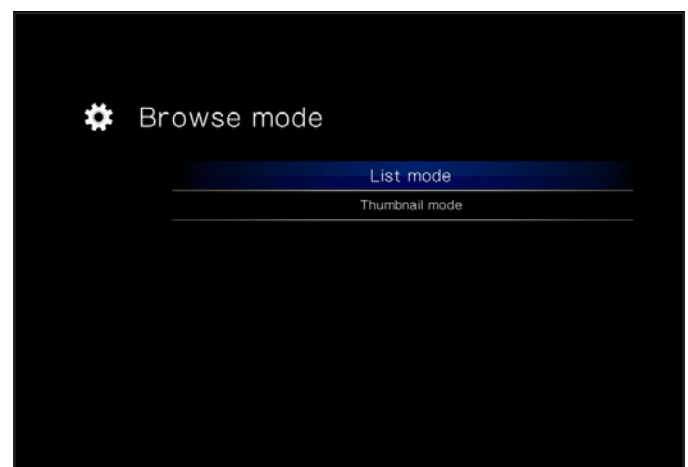

Fig. 112

---

### 9.5.5. Additional Encoding Support

Change this setting if you encounter incorrect text characters in file names in the drive operating system (default is [Western Europe](#)) ([Fig. 113](#)).

### 9.5.6. System Reset

This feature allows you to reset the product to its factory defaults, erasing all files and reverting all settings ([Fig. 114](#)).

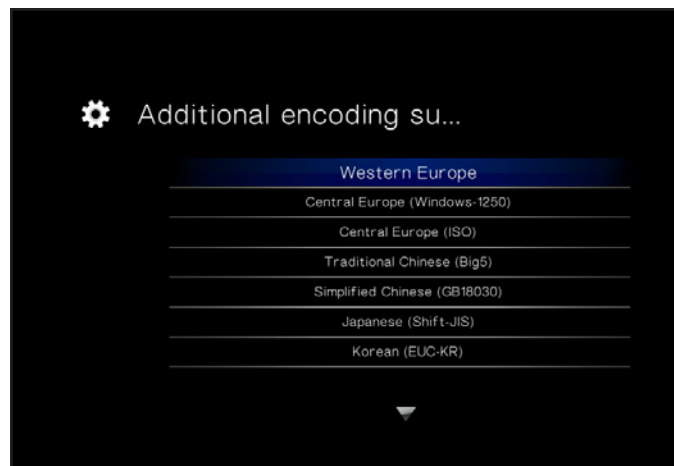

Fig. 113

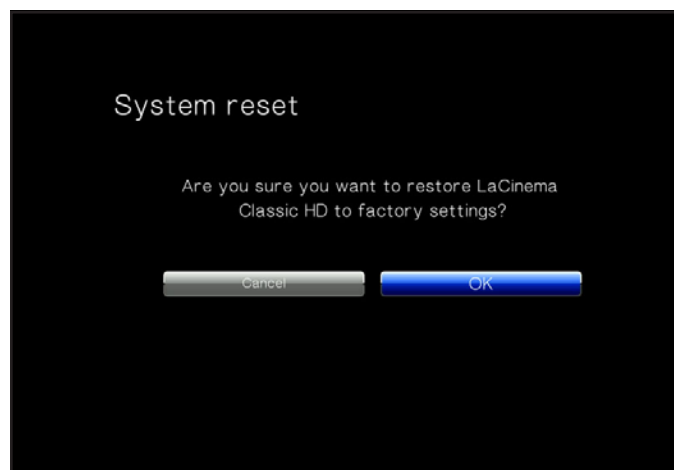

Fig. 114

### 9.5.7. About

Clicking this feature will provide you with the firmware version of your LaCinema HD Connect (Fig. 115).

### 9.5.8. Update Device

This feature allows you to update your LaCinema HD Connect's operating system.

#### Update using USB Key

If the drive does not have internet access, you can download an update file from the LaCie website, copy it to a USB flash drive, and connect the drive to the front port of the LaCinema HD Connect. An icon will appear in the Settings Space when a valid update file is detected (Fig. 116). Select this option and confirm (Fig. 117). When it has finished updating, the product will restart.

#### Update through Internet Access

If your drive is connected to the network and has access to the internet, click the **OK** button to check for updates (Fig. 116). If updates are available, they will be listed. Click the **OK** button to download and install. When it has finished updating, the product will restart.

The device will also perform an automatic check when you restart the product.

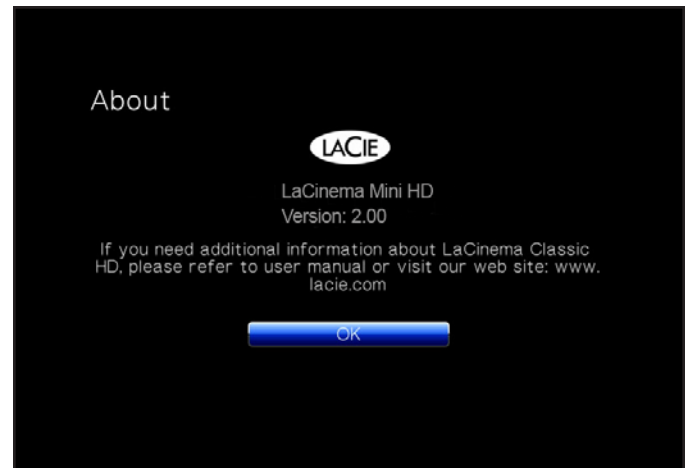

Fig. 115

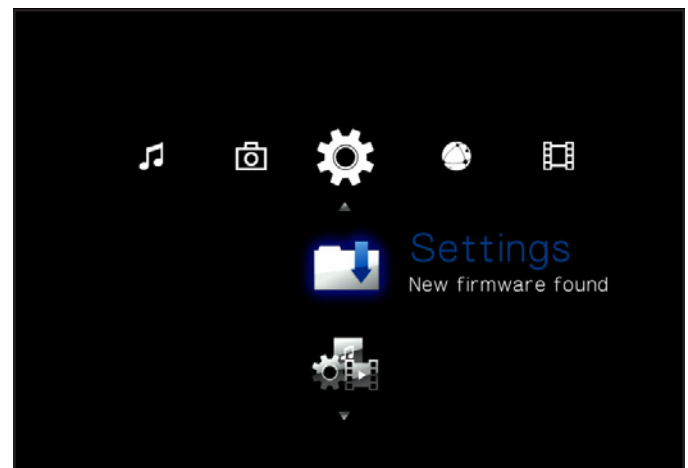

Fig. 116



Fig. 117

## 9.6. Settings: Network

### 9.6.1. Network Setup: Wired / Wireless

This page will display your LaCinema HD Connect's network values, such as IP address (Fig. 119). To modify these values, click the **Configure** button.

1. **Wired/Wireless:** Choose whether your network connection is wired (Ethernet) or wireless (WiFi). Make sure that you have connected the product to your network via Ethernet or WiFi dongle (sold separately).
2. **DHCP/Static IP:** Choose DHCP if your device is automatically assigned an IP address by your router, or static IP if you want to assign an IP address (Fig. 120).
3. If you chose wired, configuration is complete. If you chose wireless:
  - a. Select **Wireless Favorites** from the menu.
  - b. Choose your wireless network and press **Connect Now**.
  - c. You can configure multiple wireless networks from this page. To set one network as preferred, and therefore the server that the LaCinema HD Connect will connect to automatically, select the network and select the **Favorites** button.
  - d. When you see the successful connection icon to the right of the network listing, you can click the **Close** button.

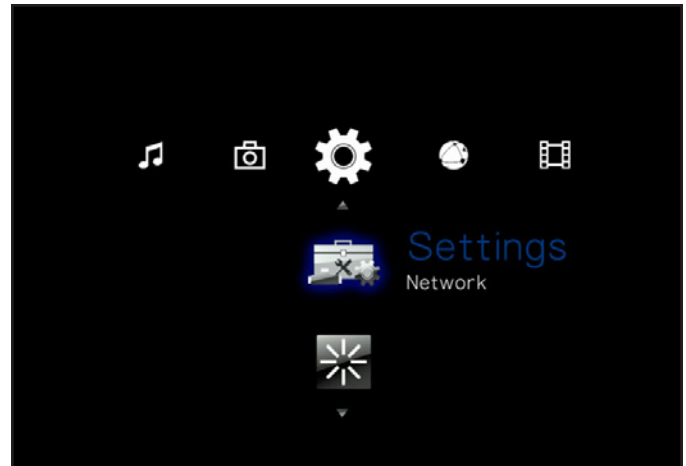

Fig. 118

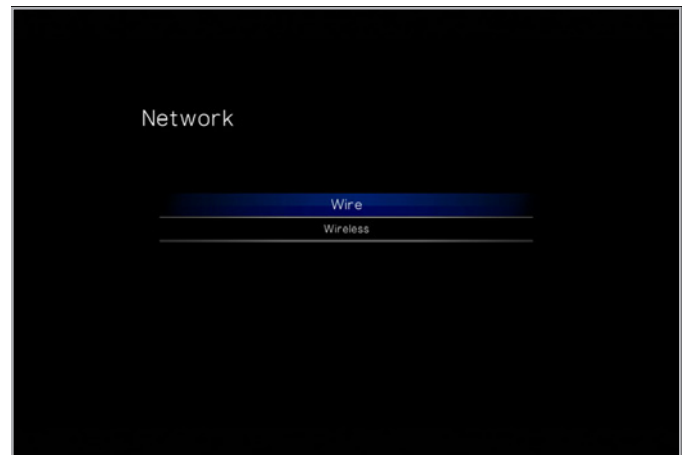

Fig. 119



Fig. 120

### 9.6.2. Device Name

This page allows you to change the device name of your LaCinema HD Connect. This is the name that will appear on your network. (Fig. 121). Use the arrow keys and the **OK** button to use the on-screen keyboard to type a new name.

### 9.6.3. Shared Folders

Use this page to turn on or off shared folder (SMB/Samba) support (default is ON). SMB is a network protocol that allows you to access the LaCinema HD Connect's volume using your operating system's file system (Windows - Explorer window; Mac - Finder window). For details on accessing your drive using SMB, see [7. Sharing Files Throughout Your Home Network](#). (Fig. 122)

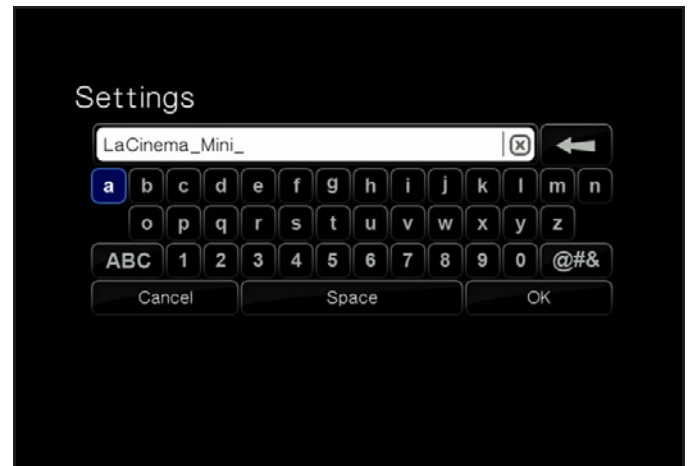

Fig. 121



Fig. 122

#### 9.6.4. Auto Login

This feature allows your LaCinema HD Connect to connect automatically to your wireless network (default is **ON**) (Fig. 123). If auto login is turned off, you will need to type your network password each time your drive is turned on.

#### 9.6.5. Clear Account Information

This function will delete your network login credentials from the LaCinema HD Connect's operating system. Press **OK** to confirm (Fig. 124).

### 9.7. Settings: Shutdown

This menu will allow you to shut down the LaCinema HD Connect or restart it in the case you encounter a playback issue (Fig. 125).

#### 9.7.1. Shutdown

By pressing the **Shutdown** button, you will enter a low power consumption mode which will make the hard drive stop spinning. To restart the product, press the power button on the remote control.

#### 9.7.2. Restart

By pressing the **Restart** button, you will initiate a restart process, which could resolve playback issues. During a restart, all network file transfer processes will be terminated (Fig. 125).

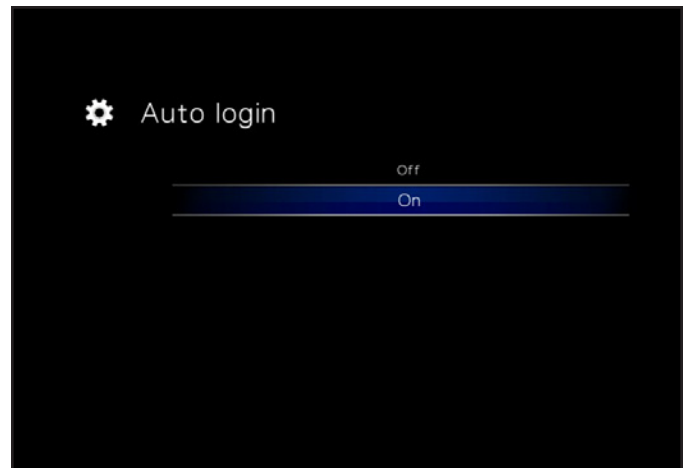

Fig. 123

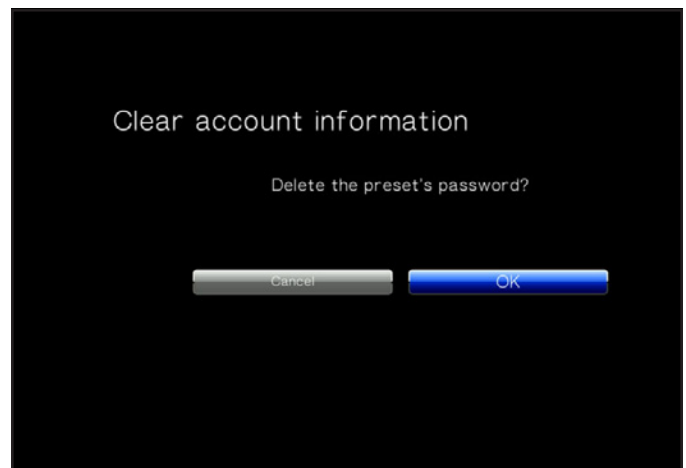

Fig. 124

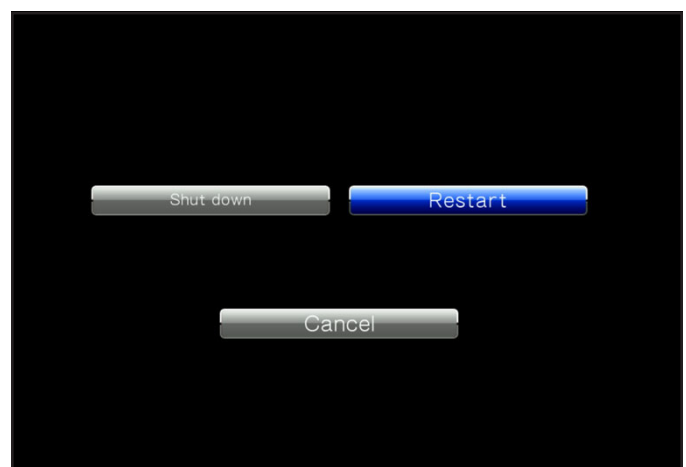

Fig. 125

## 10. Troubleshooting

If your LaCinema HD Connect is not working correctly, please refer to the following checklist to determine the source of the problem. If you have gone through all of the points on the checklist and your LaCinema HD Connect still does not work properly, please check the FAQs that are regularly published on our website – [www.lacie.com](http://www.lacie.com). One of these FAQs may provide an answer to your specific question. You can also visit the downloads page, where the most recent software updates will be available.

If you need further assistance, please contact your LaCie reseller or LaCie Customer Support (see section [11. Contacting Customer Support](#) for details).

### Manual Updates

LaCie strives to give you the most up-to-date, comprehensive user manuals available on the market. It is our goal to provide you with a friendly, easy-to-use format that will help you quickly install and utilize the many functions of your new device.

If your user manual does not reflect the configuration of the product you purchased, please check our website for the most current version of the user manual.

[www.lacie.com](http://www.lacie.com)

---

## 10.1. Troubleshooting the Television/Stereo Connection

Problem	Question	Answer
The product is connected, but the TV doesn't recognize it.	Have you properly set the video output parameters in the <b>Settings</b> menu?	Using the remote control, click the <b>Info</b> button to change from HDMI (default) to Composite Video Out mode.
Checking the firmware version.	How do you know which firmware version your LaCinema HD Connect is using?	To check which firmware is currently installed on your LaCinema HD Connect, attach it to your TV and use the remote control to navigate to the <b>Settings</b> menu. The firmware version is displayed in the bottom right corner of the <b>Settings</b> menu.
	How do you get new firmware, and how do you install it?	For a detailed explanation, please see section <a href="#">9.5.8. Update Device</a> or go to <a href="http://www.lacie.com">www.lacie.com</a> .
There is no picture being displayed.	Are all of the cables connected correctly?	Ensure that all of the cables are connected correctly. See section <a href="#">3. Setting Up: Connecting to TV &amp; Network</a> .
The picture is in black and white or there is no picture being displayed.	Is the LaCinema HD Connect's Video setting correctly set?	In the event that there is an error with the Video setting, press the <b>Info</b> button on the remote control until the correct image is displayed. Once the picture is being displayed, go into the <b>Settings</b> menu and select <b>Video</b> . From there, you can select the correct settings. For more information, please see section <a href="#">9.2. Settings: Video</a> .
Optimizing video connections.	What connectivity method will produce the best quality?	For optimal quality and performance, the best video connection is the HDMI cable (included).
There is no sound when connecting the LaCinema HD Connect to a digital stereo.	Have the Audio Settings been adjusted?	When using the A/V cable to connect the LaCinema HD Connect to a TV, go into the <b>Settings</b> menu and select <b>Audio Settings</b> . From this menu, you will need to select the <b>Analog</b> option instead of <b>Digital</b> .
Slideshows are sluggish.	Does it take several seconds to load a picture?	Depending on file size, photos may take several seconds to load properly. Reducing the photo's resolution will reduce the file size, as well, and allow the file to load faster.



## 10.2. USB Hard Drive Connection

Problem	Question	Answer
I'm not sure if my external USB hard drive is recognized by the LaCinema Connect HD.	Using the remote control, navigate to one of these spaces: Music, Photo, or Movie, and see if <b>USB1</b> is listed. If it is, your hard drive is recognized.	
The external USB hard drive isn't recognized by the LaCinema Connect HD.	Is the drive formatted in a compatible file system?	Check section <a href="#">4.1.1. Compatibility</a> to see if your drive's file system is compatible with the LaCinema HD Connect. Note that drives formatted in HFS+ (Mac OS extended) <u>Journaled</u> are incompatible. To reformat the drive, see <a href="#">8. Formatting External USB Hard Drives</a> .
	Is the drive receiving enough power?	Make sure the drive's power supply is connected and the drive is turned on. If your drive has an optional power supply, connect it.
	Did you follow the setup steps in the prescribed order?	See <a href="#">4. Setting Up: Connecting USB Hard Drive</a> .
	Try physical troubleshooting.	<ol style="list-style-type: none"> <li>1. Change the USB cable. A failure in the cable can prevent a proper connection.</li> <li>2. Change the drive's external power supply or cable.</li> <li>3. Try a different USB hard drive.</li> </ol>
A file doesn't appear on my TV or doesn't play correctly.	Is the file compatible with the LaCinema HD Connect?	See <a href="#">1.2. Supported Formats</a> to verify that the file is compatible.

# 11. Contacting Customer Support

## Before You Contact Technical Support

1. Read the manuals and review section [10. Troubleshooting](#).
2. Try to isolate the problem. If possible, make the drive the only external device on the CPU, and make sure that all of the cables are correctly and firmly attached.

If you have asked yourself all of the pertinent questions in the troubleshooting checklist, and you still can't get your LaCie drive to work properly, contact us at [www.lacie.com](http://www.lacie.com). Before contacting us, make sure that you are in front of your computer and that you have the following information on hand:

Information	Location
1. LaCie hard drive serial number	Located on a sticker at the back of drive or on the original packaging
3. Macintosh/PC model	<b>Mac users:</b> Click on the Apple icon in the menu bar and select <b>About This Mac</b> .
4. Operating system version	
5. Processor speed	
6. Computer memory	<b>Windows users:</b> Right click <b>My Computer</b> and select <b>Properties &gt; General</b> .
7. The brands and models of other internal and external peripherals installed on your computer	<b>Mac users:</b> Click on the Apple icon in the finder bar and select <b>About This Mac</b> . Select <b>More Info...</b> The Apple System Profiler will launch and will list your internal and external peripherals. <b>Windows users:</b> Right click <b>My Computer</b> and select <b>Properties &gt; Hardware</b> .

## 11.1. LaCie Technical Support Contacts

<p>LaCie Asia <a href="http://www.lacie.com/cn/contact/">http://www.lacie.com/cn/contact/</a></p>	<p>LaCie Australia <a href="http://www.lacie.com/au/contact/">http://www.lacie.com/au/contact/</a></p>
<p>LaCie Belgium <a href="http://www.lacie.com/be/contact/">http://www.lacie.com/be/contact/</a> (Dutch) <a href="http://www.lacie.com/befr/contact/">http://www.lacie.com/befr/contact/</a> (French)</p>	<p>LaCie Brazil <a href="http://www.lacie.com/us/contact/">http://www.lacie.com/us/contact/</a></p>
<p>LaCie Canada <a href="http://www.lacie.com/ca/contact/">http://www.lacie.com/ca/contact/</a> (English) <a href="http://www.lacie.com/cafr/contact/">http://www.lacie.com/cafr/contact/</a> (French)</p>	<p>LaCie Denmark <a href="http://www.lacie.com/dk/contact/">http://www.lacie.com/dk/contact/</a></p>
<p>LaCie Finland <a href="http://www.lacie.com/fi/contact/">http://www.lacie.com/fi/contact/</a></p>	<p>LaCie France <a href="http://www.lacie.com/fr/contact/">http://www.lacie.com/fr/contact/</a></p>
<p>LaCie Germany <a href="http://www.lacie.com/de/contact/">http://www.lacie.com/de/contact/</a></p>	<p>LaCie Ireland <a href="http://www.lacie.com/ie/contact/">http://www.lacie.com/ie/contact/</a></p>
<p>LaCie Italy <a href="http://www.lacie.com/it/contact/">http://www.lacie.com/it/contact/</a></p>	<p>Japan – Elecom CO., LTD. <a href="http://www.lacie.com/jp/contact/">http://www.lacie.com/jp/contact/</a></p>
<p>LaCie Korea <a href="http://www.lacie.com/kr/contact/">http://www.lacie.com/kr/contact/</a></p>	<p>LaCie Latin America <a href="http://www.lacie.com/la/contact/">http://www.lacie.com/la/contact/</a></p>
<p>LaCie Netherlands <a href="http://www.lacie.com/nl/contact/">http://www.lacie.com/nl/contact/</a></p>	<p>LaCie Norway <a href="http://www.lacie.com/no/contact/">http://www.lacie.com/no/contact/</a></p>
<p>LaCie Portugal <a href="http://www.lacie.com/pt/contact/">http://www.lacie.com/pt/contact/</a></p>	<p>LaCie Singapore <a href="http://www.lacie.com/asia/contact/">http://www.lacie.com/asia/contact/</a></p>
<p>LaCie Southeast Asia <a href="http://www.lacie.com/sea/contact/">http://www.lacie.com/sea/contact/</a></p>	<p>LaCie Spain <a href="http://www.lacie.com/es/contact/">http://www.lacie.com/es/contact/</a></p>
<p>LaCie Sweden <a href="http://www.lacie.com/se/contact/">http://www.lacie.com/se/contact/</a></p>	<p>LaCie Switzerland <a href="http://www.lacie.com/ch/contact/">http://www.lacie.com/ch/contact/</a> (German) <a href="http://www.lacie.com/chfr/contact/">http://www.lacie.com/chfr/contact/</a> (French) <a href="http://www.lacie.com/chit/contact/">http://www.lacie.com/chit/contact/</a> (Italian)</p>
<p>LaCie UK <a href="http://www.lacie.com/uk/contact/">http://www.lacie.com/uk/contact/</a></p>	<p>LaCie USA <a href="http://www.lacie.com/us/contact/">http://www.lacie.com/us/contact/</a> (English) <a href="http://www.lacie.com/uses/contact/">http://www.lacie.com/uses/contact/</a> (Spanish)</p>
<p>LaCie Grand Export <a href="http://www.lacie.com/intl/contact/">http://www.lacie.com/intl/contact/</a></p>	

## 12. Warranty Information

This Limited Warranty applies only to hardware products manufactured by or for LaCie that can be identified by the “LaCie” trademark, trade name, or logo affixed to them. The Limited Warranty does not apply to any non-LaCie hardware products or any software, even if packaged or sold with LaCie hardware. Manufacturers, suppliers, or publishers, other than LaCie, may provide their own warranties to the end user purchaser, but LaCie, in so far as permitted by law, provides their products “as is”. Software distributed by LaCie with or without the LaCie brand name (including, but not limited to system software) is not covered under this Limited Warranty. Refer to the licensing agreement accompanying the software for details of your rights with respect to its use.

LaCie does not warrant that the operation of the product will be uninterrupted or error-free. LaCie is not responsible for damage arising from failure to follow instructions relating to the product’s use. This warranty does not apply:

- to consumable parts, unless damage has occurred due to a defect in materials or workmanship;
- to cosmetic damage, including but not limited to scratches, dents and broken plastic on ports;
- to damage caused by use with non-LaCie products;
- to damage caused by accident, abuse, misuse, flood, fire, earthquake or other external causes;
- to damage caused by operating the product outside the permitted or intended uses described by LaCie;
- to damage caused by service (including upgrades and expansions) performed by anyone who is not a representative of LaCie or a LaCie Authorized Service Provider;
- to a product or part that has been modified to alter functionality or capability without the written permission of LaCie; or
- if any LaCie serial number on the product has been removed or defaced.

To obtain warranty service, call LaCie Technical Support. You will be asked to provide your LaCie product’s serial number, and you may be asked to furnish proof of purchase to confirm that the drive is still under warranty.

All drives returned to LaCie must be securely packaged in their original box and shipped with postage prepaid.

---

---

**IMPORTANT INFO:** Register online for free technical support: [www.lacie.com/register](http://www.lacie.com/register)

---

---